



FILE COPY

Not to be removed from
the offices of Electrical
Communication.

ELECTRICAL COMMUNICATION

APRIL

No. 4

1936

VOL. 14

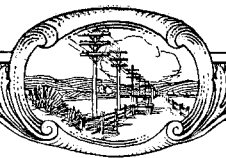

ELECTRICAL COMMUNICATION

A Journal of Progress in the
Telephone, Telegraph and Radio Art

H. T. KOHLHAAS, Editor

EDITORIAL BOARD

E. A. Brofos P. K. Condict G. Deakin E. M. Deloraine P. E. Erikson James E. Fullam
J. J. Gilbert F. Gill Frank C. Page H. M. Pease Kenneth E. Stockton

Published Quarterly by the

International Standard Electric Corporation

Head Offices

67 BROAD STREET, NEW YORK, N. Y., U. S. A.

European General Offices

CONNAUGHT HOUSE, ALDWYCH, LONDON, W. C. 2, ENGLAND

P. K. Condict, President

S. G. Ordway, Secretary

Joseph A. Redegeld, Treasurer

Subscription, \$3.00 per year; single copies 75 cents

Volume XIV

APRIL, 1936

Number 4

CONTENTS

	PAGE
A MOULDED BAKELITE SET WITH A NEW MICROTELEPHONE <i>By L. C. Pocock and L. Schreiber</i>	261
A SEARCH-COIL METHOD OF MEASURING THE A-C. RESISTIVITY OF THE EARTH..... <i>By John Collard</i>	270
INTERMODULATION IN LOADED TELEPHONE CABLES..... <i>By K. E. Latimer</i>	275
THE TELEPHONE AND SIGNALING SYSTEMS ON SS. NORMANDIE..... <i>By S. V. C. Scruby</i>	297
FEDERAL DISTRICT 7-A.2 ROTARY AUTOMATIC EXCHANGE "48," INAUGURATED JUNE 29, 1935 BY THE BRAZILIAN TELEPHONE COMPANY.....	314
TERÉZ AUTOMATIC EXCHANGE—BUDAPEST AREA—20,000 LINES IN ONE ROOM..... <i>By J. Sarospatak</i>	323
NOTES ON PIEZOELECTRIC QUARTZ CRYSTALS..... <i>By Issac Koga</i>	327
YOUNG'S MODULUS OF A CRYSTAL IN ANY DIRECTION... <i>By Issac Koga</i>	339
MICRO-RAY COMMUNICATION..... <i>By W. L. McPherson and E. H. Ullrich</i>	340
PROCEEDINGS OF THE INTERNATIONAL TELEPHONE CON- SULTATIVE COMMITTEE (C.C.I.F.) BUDAPEST, SEPT. 3-10, 1934. English Edition.....	347
RECENT TELECOMMUNICATION DEVELOPMENTS OF INTEREST	348

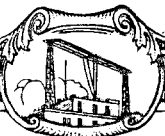

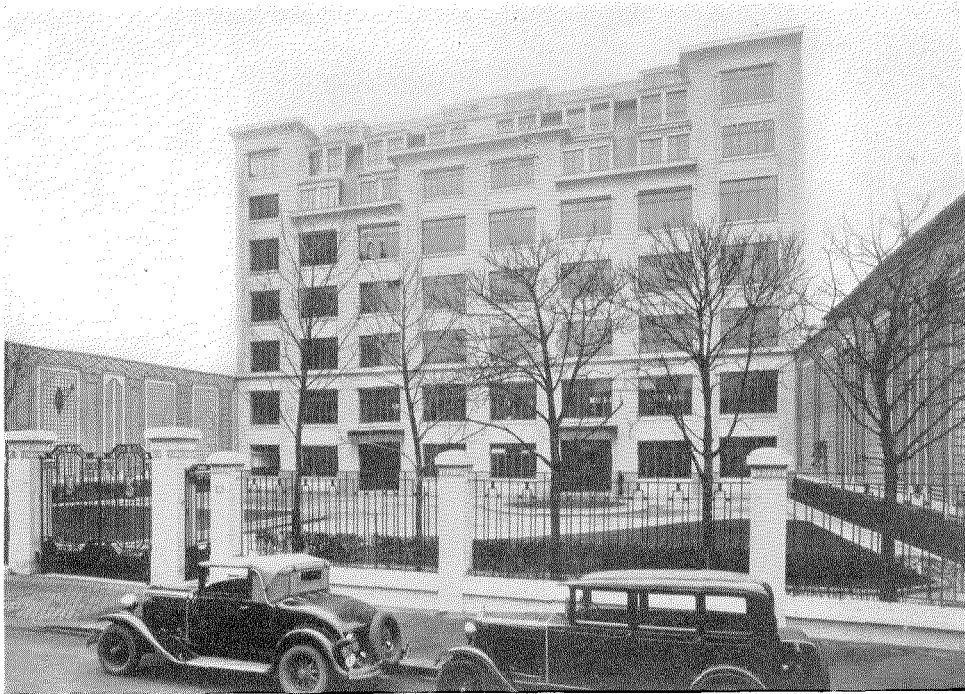

LES LABORATOIRES
LE MATÉRIEL TÉLÉPHONIQUE
Paris, France

A. Moulded Bakelite Set with a New Microtelephone

By L. C. POCOCK

Standard Telephones and Cables, Ltd., London, England

and

L. SCHREIBER

Bell Telephone Manufacturing Company, Antwerp, Belgium

IN a previous issue of *Electrical Communication*,¹ developments in subscribers' sets by the Bell Telephone Manufacturing Company over a period of twenty years are described. They include the design of moulded bakelite sets of the wall and table types. In the present article, the moulded sets and the new microtelephone are described in greater detail, and information is given on the circuit and transmission characteristics of the combination.

The moulded bakelite sets continue the "unit type" feature—originally designed by the company in 1912—the designation "unit type" referring to the fact that all the components are contained within the housing of the set. The outstanding mechanical design feature of the "unit type" moulded sets is the use of a metal base plate carrying all the components, such as ringer, induction coil, condenser, gravity switch, and terminal strip, the base plate being *identical for both table and wall sets*. The moulded bakelite cases or housings are of two different forms—one for the table set and the other for the wall set—and contain the switch plunger and facilities for mounting the dial. This interchangeable, fully equipped base plate is an important feature, both from the viewpoint of the manufacturer and the operating organization, inasmuch as it provides means for easy conversion from table to wall set or vice versa.

Figs. 1 and 2 illustrate the table and wall set, respectively, and Fig. 3 shows the common base plate. The sets are furnished in sixteen different colors: the black, red, blue, green, and imitation wood colored sets are made of bakelite, while the white and cream colored sets are made from



Figure 1—Moulded Subscriber Set—Table Type.

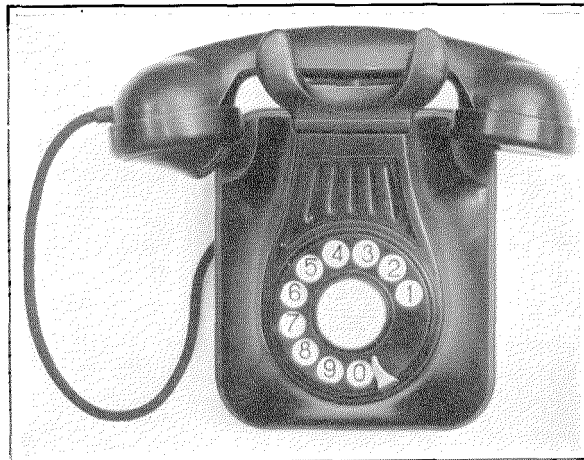

Figure 2—Moulded Subscriber Set—Wall Type.

Urea moulding material, inasmuch as bakelite is unsuitable for light colors.

The dial, large numbers of which are in service,

¹"Development in Subscriber Sets," by L. Schreiber, *Electrical Communication*, July, 1935.

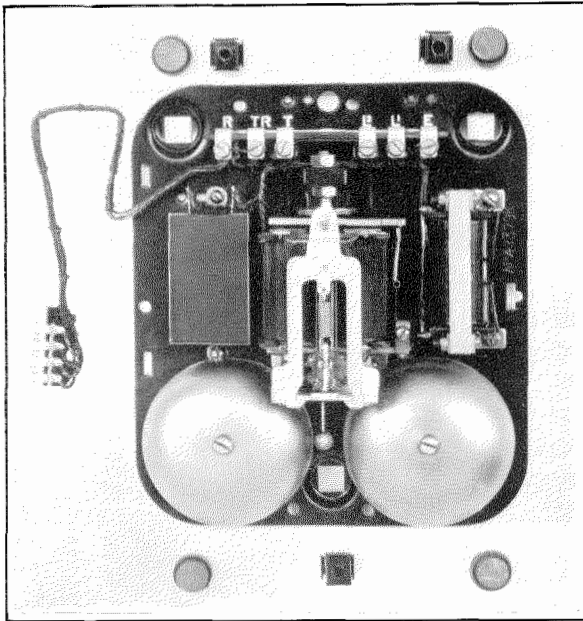

Figure 3—Common Base Plate of Moulded Subscriber Set.

is of simple and robust construction, with finger holes larger than in other known commercial types. The lightness of the aluminium alloy die cast finger plate, the low friction of the rotating elements, and the practically uniform tension of the clock spring throughout the travel, make possible a particularly low tension on the finger plate when the dial is wound up. The dial is also very quiet in operation, a result achieved by the use of an aluminium alloy die cast body, which damps the sound produced by the gears, rather than intensifying it, as is the case with a punched metal body.

The normal dial speed is 10 steps per second. The dial is of the uniform break impulse type with a ratio of break-to-make of $66\% \pm 3\%$.

Fig. 4 illustrates the constructional details of the dial. The short-circuiting contact unit can be modified according to circuit conditions. The governor speed in respect to the finger plate speed is in the ratio of 83 to 1. This relatively high speed of the governor and the low inertia of the rotating elements of the dial (finger plate, spindle, and bakelite cam) result in a uniform speed during the impulse sending, the normal speed being reached after the finger plate is released and well before the first impulse is

produced. The clock spring is adjustable from the front of the dial after removal of the instruction card. Speed adjustment, when required in service, can be made without the necessity of opening the set or removing the dial from the set. To maintain proper lubrication, the spindle is of hollow construction with a small hole and is furnished with a wick. The wearing qualities of the dial are such that after 1,000,000 full revolutions no sign of wear is noticeable and speed variations and impulse ratios remain within the prescribed limits.

By introducing modifications in the magnetic circuit of the ringer, it has been found possible to increase the sound efficiency about 25%.

The closed core induction coil with silicon steel laminations is of the three winding type for anti-side tone circuit and has only four terminals. The core is designed to function with the high magnetising currents of the 48 volt toll switching repeating coil cord circuits.

The design of the moulded microtelephone was adopted after extensive study of the advantages and disadvantages, both to the manufacturer and the operating organization, of the various forms in which a microtelephone can be assembled. The outcome is the three piece design shown in Fig. 5, consisting of a handle, a mouth-piece, and an earpiece.

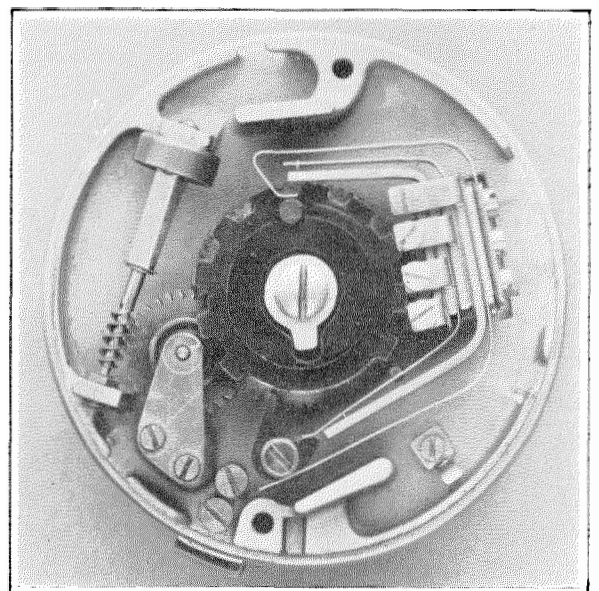

Figure 4—Constructional Details of the Dial.

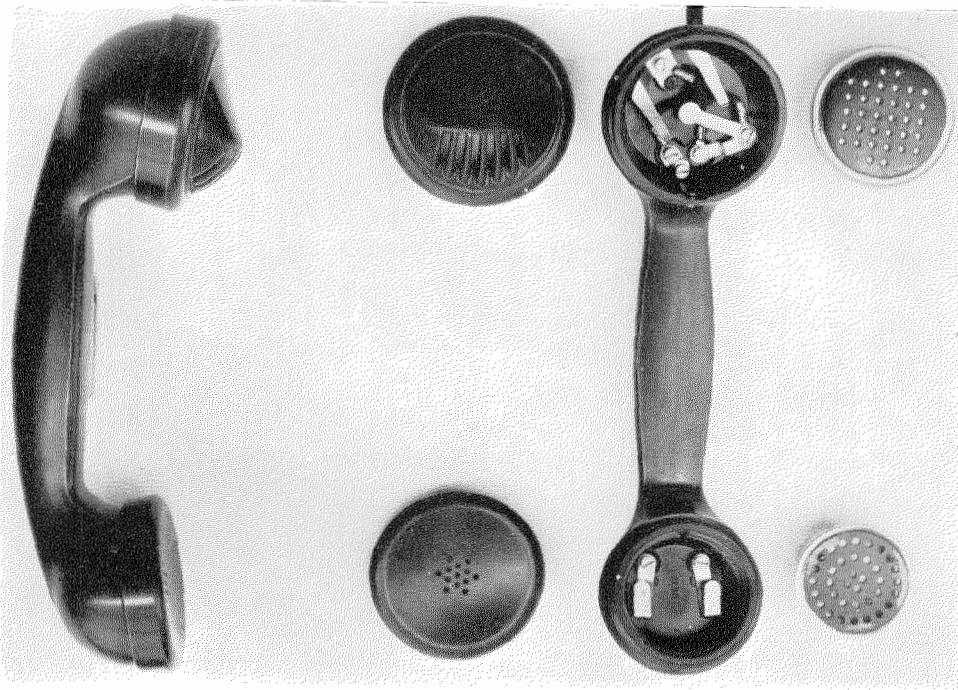

Figure 5—Moulded Microtelephone.

The mouthpiece is of the slotted type: considerable care has been taken in its design to avoid loss of efficiency and to safeguard articulation. Both the mouthpiece and the earpiece screw on to the handle with threads of a coarse steep pitch and hold the microphone and receiver capsules in their respective receptacles.

High efficiency and good articulation of the microphone are achieved by a design embodying moving parts of exceptionally low mass (Figs. 6 and 7). The principal feature of the microtelephone which has now been in use for some years is the flexible construction of the silk carbon chamber.

Some small recent improvements have been introduced, namely, the use of non-corrodible alloy for the diaphragm, and the use of tin foil as an additional protection against the penetration of moisture deposited from the breath in the transmitter front.

Two slightly different microphone capsules of

this type are available: one for use with high current cord circuits; the other, with low current cord circuits generally used in Central Europe. While it is not contemplated that the two types of microphone will be used generally in one telephone system, it may be pointed out that the microphone designed for low current may be useful on account of its higher efficiency under this condition, if it is desired to bring some exceptionally long lines within the reference equivalent limits proposed by the C.C.I.F.

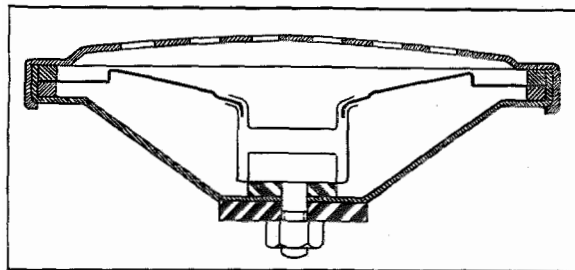

Figure 6—Part Section through Case of Microphone.

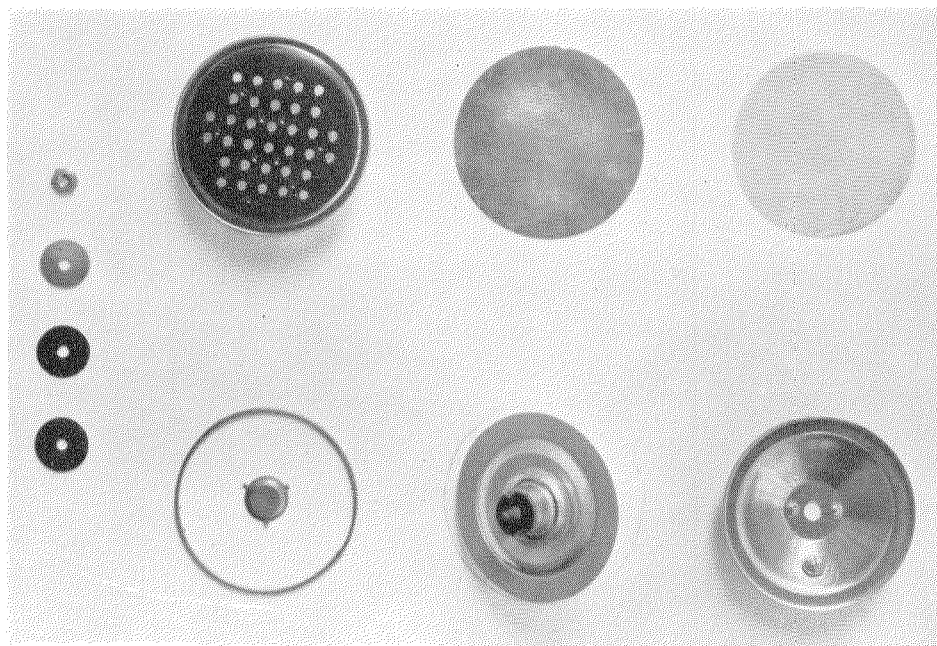

Figure 7—Microphone Capsule Parts.

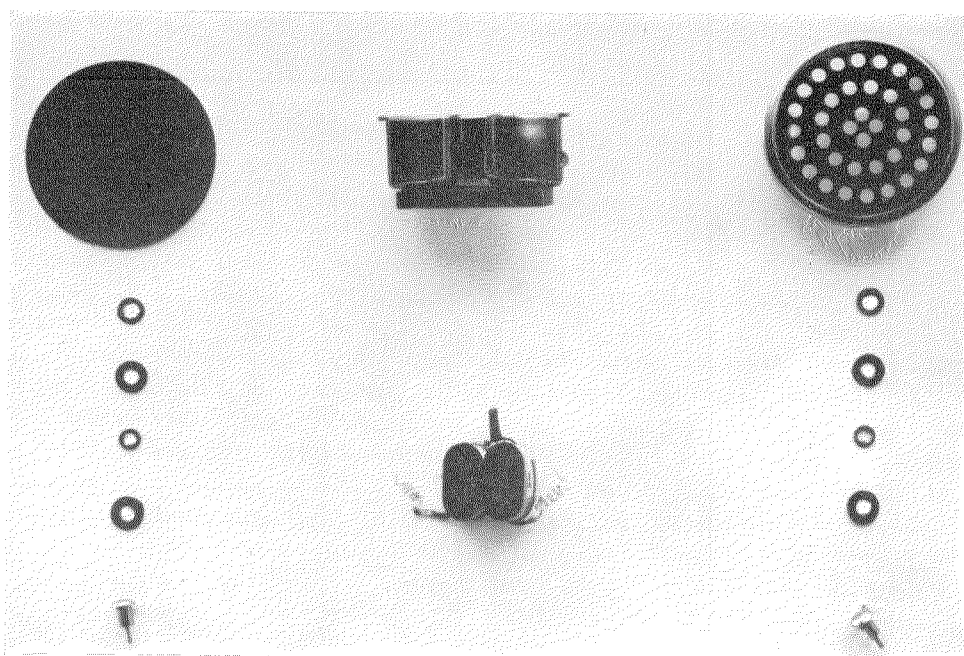

Figure 8-A—Receiver Capsule Parts.

The receiver capsule illustrated in Figs. 8-A and 8-B is a new design. It is provided with a short, high coercive force, cobalt steel magnet to which the two cores of the spools are welded electrically. This design of magnetic circuit was first adopted some 12 years ago and has been found satisfactory in several receiver designs. To protect the diaphragm against accidental damage, there is provided a perforated cover which also clamps the diaphragm to the capsule case. The design is very efficient, as may be seen from the reference equivalent hereinafter quoted. While receivers give but little trouble, the capsule form has been adopted inasmuch as the ease with which substitutions can be effected encourages maintenance men to bring in for test any receiver regarding which there is the slightest question.

The Circuit

The circuit schematic shown in Fig. 9-A is similar to the well known circuit used with the older type sets, but with the addition of an anti-side tone winding across the receiver. The following features are to be found in this circuit:

- (1) The switch hook contacts are placed adjacent to terminals 1 and 3 of the induction coil. By this arrangement only four terminals are needed on the induction coil and, more important, it places the capacity to frame of the windings between the break and the microphone and thereby reduces to a negligible amount the coherer action of the microphone produced by high frequency discharges when the switch hook is operated.
- (2) The same condenser is used in the ringing and talking circuits.
- (3) The dialing circuit has a coil winding and condenser across the impulsing contacts, thus keeping the voltage generated at break within reasonable and safe limits. Both transmitter and receiver are short-circuited by the off-normal contacts.
- (4) Provision is made for fitting an extension ringer in series with the normal ringer.
- (5) The microtelephone is connected by a three-way cord.
- (6) For two-party line selective ringing the circuit of Fig. 9-B is used.

Fig. 10 shows the transmitting and receiving characteristics of the set when a constant e.m.f. is applied in the microphone circuit or in a 600 ohm line impedance.

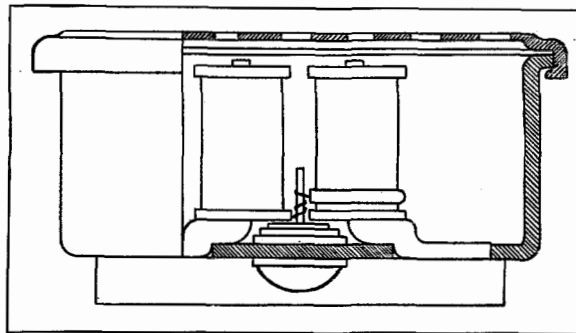

Figure 8-B—Part Section through Case of Receiver Unit.

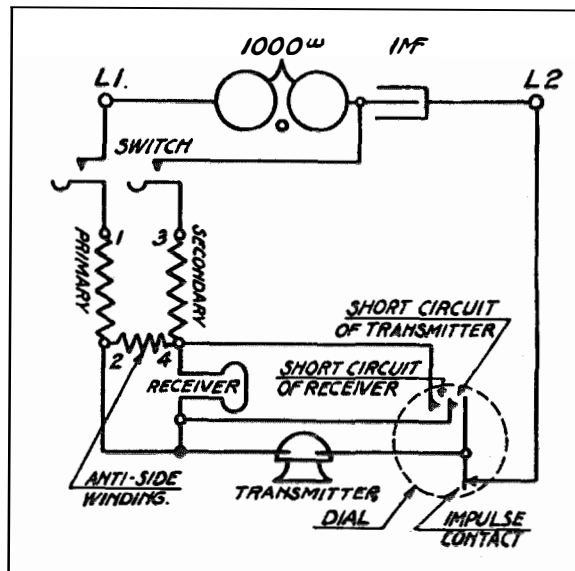

Figure 9-A—Circuit Schematic of Moulded Bakelite Set

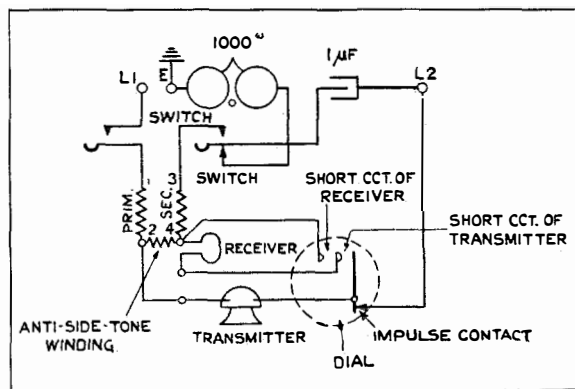

Figure 9-B—Two Party Line Telephone.

TABLE I
TRANSMITTING AND RECEIVING REFERENCE EQUIVALENTS

Cord Circuit 48 volts 250 + 250 ohms (Rotary)
Local Lines Pure resistance
Microphone Type A (6 tested)

Local Line Resistance	Transmitting Reference Equivalent			Receiving Reference Equivalent		
	Set 1	Set 2	Average	Set 1	Set 2	Average
50	+ 0.3 db.	+ 0.7 db.	+ 0.5 db.	—	—	—
300	+ 4.7 db.	+ 4.7 db.	+ 4.7 db.	+ 1.6 db.	+ 1.5 db.	+ 1.5 db.
600	+ 7.7 db.	+ 8.3 db.	+ 8.0 db.	—	—	—

TABLE II
TRANSMITTING REFERENCE EQUIVALENTS

Cord Circuit 48 volts 200 + 200 ohms (Step by step cord circuit)
Local Line 300 ohms
Microphone Type A (6 tested)

Set 1	Set 2	Average
+ 3.2 db.	+ 2.8 db.	+ 3.0 db.

TABLE III
TRANSMITTING REFERENCE EQUIVALENTS

Cord Circuits 60 volt 500 + 500 ohms
24 volt 400 + 400 ohms
Local Line 0 and 300 ohms
Microphone Type B (6 tested)

Local Line Resistance	60 Volts 500 + 500 Ohms Cord Circuit			24 Volts 400 + 400 Ohms Cord Circuit		
	Set 1	Set 2	Average	Set 1	Set 2	Average
300 0	+ 4.4 db. —	+ 3.6 db. —	+ 4.0 db. —	+ 9.3 db. (3 Microphones)	+ 8.7 db.	+ 9.0 db. + 4.3 db.
300	REPORT 93		+ 3.5 db.			

TABLE IV
TRANSMITTING AND RECEIVING REFERENCE EQUIVALENTS

Cord Circuit SETAC—(24 Volt Repeating Coil Cord Circuit)
Local Lines Pure Resistance
Microphone Type A (6 tested)

Local Line Resistance	Transmitting Reference Equivalent*			Receiving Reference Equivalent		
	Set 1	Set 2	Average	Set 1	Set 2	Average
50	- 2.0 db.	- 2.9 db.	- 2.5 db.	—	—	—
300	+ 4.5 db.	+ 4.2 db.	+ 4.3 db.	+ 1.1 db.	+ 1.9 db.	+ 1.5 db.
600	+ 7.7 db.	+ 8.3 db.	+ 8.0 db.	—	—	—
300	REPORT 93		+ 4.2	REPORT 93		+ 2.3

*These values should be made 1.5 db. better to represent the transmitting Reference Equivalent with the Standard Test Circuit or corresponding Repeating Coil Cord Circuit of "Standard" Manufacture. Physical measurements have shown that the SFERT laboratory SETAC which was used in these tests is 1.5 db. poorer when transmitting than the "Standard" Test Circuit.

TABLE V
 VARIATION OF TRANSMITTING REFERENCE EQUIVALENT WITH SPEECH INTENSITY

Cord Circuit Local Lines Microphone	SETAC (24 Volt Repeating Coil Cord Circuit) 300 ohms Type A
Speech Intensity Relative to Normal Speech Intensity	Transmitting Reference Equivalent*
6 db. above normal	+ 4.6 db.
Normal	+ 4.3 db.
6 db. below normal	+ 7.0 db.

*See footnote to Table IV.

TABLE VI
 OVERALL TRANSMITTING AND RECEIVING REFERENCE EQUIVALENT

Cord Circuit	Type of Microphone	Local Line Resistance	Overall Reference Equivalent	
			Observed	Sum of Transmitting and Receiving Equivalent
24v. Repeating Coil	A	300	+ 2.8* db.	5.9* db.
48v. 250 + 250 ohms.	A	300	+ 3.9 db.	6.2 db.
60v. 500 + 500 ohms	B	300	+ 4.3 db.	5.5 db.

*See footnote to Table IV.

TABLE VII
 SIDE TONE—REFERENCE EQUIVALENT

Cord Circuit	Type of Transmitter	Local Line Resistance	Trunk	Reference Equivalent of Side Tone
48v. 250 + 250 ohms	A	50 ohms	9.8 km 22 B & S Cable	+ 8.8 db.
48v. 250 + 250 ohms	A	50 ohms	600 ohms	+ 7.4 db.
24v. 400 + 400 ohms	B	0	600 ohms	+ 10.4 db.
60v. 500 + 500 ohms	B	0	600 ohms	+ 4.7 db.

Fig. 11 shows the impedance characteristics of the set as measured at the transmitter and receiver terminals when the line impedance has the special characteristic value for which the side tone is zero. The transmitter terminal impedance is made somewhat higher than the normal transmitter resistance in order that the matching may improve rather than get worse on abnormally long local lines where the transmitter resistance is high. The transmitter resistance as a function of current is shown in Fig. 12.

The damped receiver impedance is shown in Fig. 13. It will be seen that the modulus of the impedance is of the same order as the impedance at the receiver terminals (Fig. 11) throughout the more important frequency range.

The line terminal impedance is of fundamental

importance; it has been shown elsewhere² that ideally it should be the conjugate of the no-side tone line impedance³ which should be chosen from a knowledge of actual line impedances encountered. In this set, the line terminal impedance has been chosen to match a fairly typical line impedance encountered when a call is made over a non-loaded cable trunk (Fig. 14).

Voice and Ear Transmission Test

Two telephone sets with a number of microphones and receivers were sent to the C.C.I.F.

² "Anti-Side Tone Telephone Sets," by L. C. Pocock, *Electrical Communication*, April, 1935.

³ An anti-side tone set gives no side tone at all for a particular impedance connected to the line terminals. The particular impedance is called the "no side tone impedance."

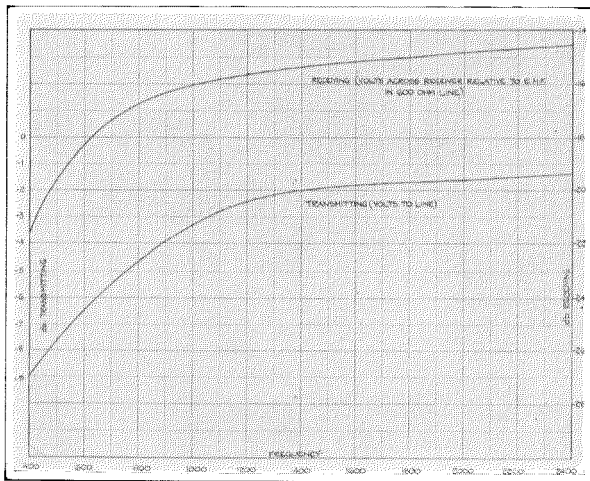

Figure 10—Frequency Characteristics of Set for Constant E.M.F. Input

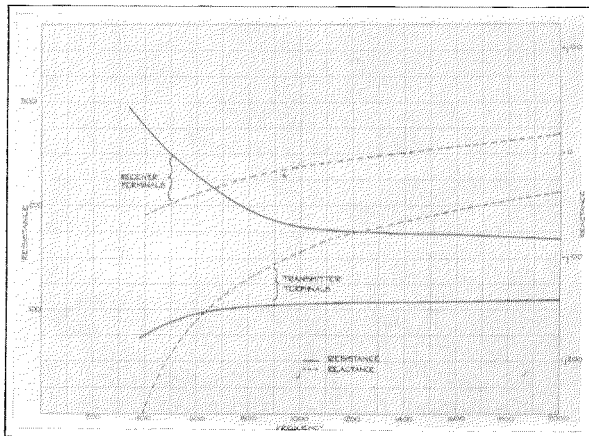

Figure 11—Impedance of Set at Transmitter and Receiver Terminals with No-Side Tone Line Impedance Connected at Line Terminals.

(SFERT) Laboratory in Paris for test under various conditions of cord circuit and local line.

During transmitting efficiency tests the microtelephone was held in the position specified (White Book, Vol. 4, p. 184), a mouth gauge so proportioned as to place the lips at the point specified by the C.C.I.F. being used. Under these conditions the lips are about 1.2 cm. from the centre of the mouthpiece. These dimensions in practice fit a large number of people, although recent measurements made by various European Administrations have clearly indicated that a different shape of microtelephone could be more

logically adopted to fit the greatest number of people. In view of this situation, when developing the microtelephone, precautions were taken in order that the design could be modified without too much expense should a desire arise for microtelephones built to correspond with head measurements determined by European Administrations.

The results obtained by the C.C.I.F. laboratory and reported in Technical Report No. 112 are shown in the tables on the preceding pages. Where the conditions correspond with tests made on the bakelite set with an earlier design of microtelephone (Technical Report 93) the average result of the earlier test is given below

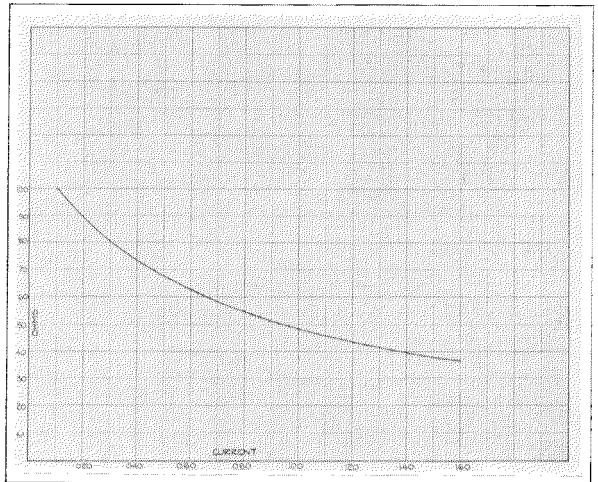

Figure 12—Talking Resistance of Microphone (Type A).

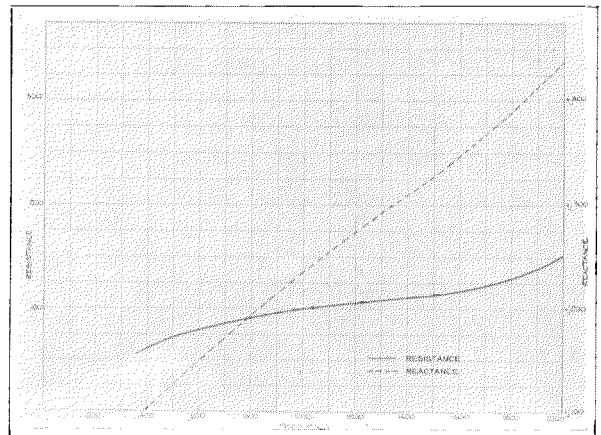

Figure 13—Damped Impedance of Receiver.

the table. Numbers with positive signs refer to the number of decibels that must be inserted in the transmitting or receiving termination of the reference system to lower its output to that of the transmitting or receiving system tested. Numbers with negative signs indicate the gain that must be applied to the transmitting or receiving termination of the reference system to equal the system tested.

Table V shows the non-linear relation of microphone output to speaking intensity. If the carbon microphone output were strictly proportional to speech intensity the Reference Equivalent would be the same at any level of speech intensity.

Overall reference equivalents directly observed do not agree exactly with the sum of the transmitting and receiving reference equivalents. The transmitting reference equivalent of a telephone set is measured by comparing it with the transmitting system of the reference system, the listener using a high quality receiving system for making the comparison. Similarly, a high quality transmitting system is used when measuring a receiving reference equivalent. The quality differences encountered in these tests seem to produce a consistently biased effect whereby the observed overall equivalent is less than the sum of the transmitting and receiving reference equivalents.

Side tone is measured by the number of deci-

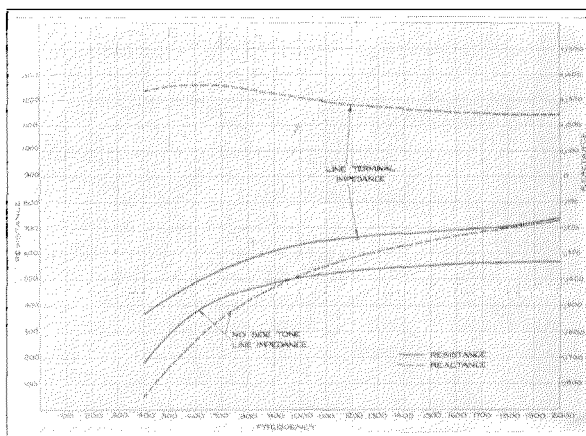

Figure 14—Line Terminal Impedance and No-Side Tone Line Impedance.

bels which must be placed in the trunk of the reference system to reduce the received volume of sound to the level heard by side tone in the receiver of the set under test. Lower side tone is therefore characterised by higher values of reference equivalents.

The figures of Table VII should be studied in conjunction with the transmitting and receiving reference equivalents inasmuch as the feature aimed at is low side tone in relation to the efficiency of the microphone and receiver. Side tone must be covered by suitable design of the set and not by lowering the efficiency.

A Search-Coil Method of Measuring the A-C. Resistivity of the Earth*

by JOHN COLLARD, Ph.D.

Associate Member

SUMMARY: *The paper describes a method of measuring the a-c. resistivity of the earth based on the Carson-Pollaczek theory for the mutual impedance of earth-return circuits. The method consists in the measurement of the e.m.f.'s. induced in a search coil placed at various distances from an earth-return circuit carrying alternating current. The experimental points are superimposed on a set of theoretical curves calculated for different values of resistivity, and the curve with which the points coincide gives the resistivity.*

Where a power line exists in the neighbourhood of the site whose resistivity is to be measured, one of the zero phase-sequence harmonics can be used as the inducing current.

The method has been used to measure the resistivity of the earth at various sites in England and Italy, and the results obtained are given, together with particulars of the geological formation at the sites.

Introduction

RECENT developments in h.t. power lines and communication circuits have emphasized the need for a method of predicting the inductive interference which will be produced in a communication circuit when paralleled by a power circuit. The prediction of the voltage produced in the communication circuit by induction from the power-circuit currents requires a knowledge of the mutual impedance between the two circuits.

Numerous tests¹ have shown that the Carson-Pollaczek theory can be used satisfactorily to determine the mutual impedance between two conductors with earth return, provided the specific resistance of the site is known. A means of determining the specific resistance of the earth is therefore very necessary, and the object of this paper is to describe such a method based on the Carson-Pollaczek theory.

Theory

The Carson-Pollaczek theory results in the

following expression for the mutual impedance between two parallel circuits with earth return:

$$M = \left[-\frac{4}{k^2 x^2} + 4 \frac{kei'(|kx|) - jker'(|kx|)}{|kx|} \right] \times 10^{-4}$$

where

- M = mutual impedance, in henrys per km;
- x = separation between the two lines, in cm;
- $k = e^{\frac{3}{4}\pi j} \sqrt{4\pi\sigma\omega}$;
- σ = conductivity of the earth, in c.g.s. units;
- e = base of natural logarithms;
- $j = \sqrt{-1}$;
- ker' and kei' = differential coefficients of ker and kei (the Kelvin forms of Bessel functions).²

Suppose now that one of the circuits is replaced by a search coil. The e.m.f. induced in the coil is a function of the field strength at the separation. The expression for m , the mutual impedance between the coil and the circuit, is therefore the differential of the above expression for M .

We thus have

$$m = \frac{dM}{dx} = \frac{kdM}{d(kx)} = kM'$$

Hence

$$\frac{m}{k} = f(kx).$$

*Reprinted by permission from the *I.E.E. Journal*, Vol. 78, No. 469, January, 1936.

¹ W. G. Radley and S. Whitehead: "Recent Investigations on Telephone Interference," *Journal I.E.E.*, 1934, vol. 74, p. 201; J. Collard: "Measurement of the Mutual Impedance of Circuits with Earth Return," *ibid.*, 1932, vol. 71, p. 674.

² For Tables of these functions see Report of the British Association, 1915, p. 36.

If, therefore, we measure the e.m.f. of the coil for different separations, different frequencies, and different resistivities, and then plot corresponding values of m/k and kx , all the points will fall on the same curve. Two values of this curve are of interest. For small values of kx the expression reduces to

$$\frac{m}{k} = \frac{2}{kx}$$

For large values of kx the expression becomes

$$\frac{m}{k} = \frac{-j8}{(kx)^3}$$

Suppose now that instead of dealing with m/k and kx we use m/\sqrt{f} and $x\sqrt{f}$: then, for small values of $x\sqrt{f}$, the expression becomes

$$\frac{m}{\sqrt{f}} = \frac{2}{x\sqrt{f}}$$

Hence for small values of $x\sqrt{f}$ the value of m/\sqrt{f} is independent of the resistivity.

For large values of $x\sqrt{f}$ we have

$$\frac{m}{\sqrt{f}} = \frac{1}{\sigma\pi^2} \cdot \frac{-j}{(x\sqrt{f})^3}$$

Hence for a given value of $x\sqrt{f}$ the corresponding value of m/\sqrt{f} will depend on the resistivity. We thus obtain a family of curves of which the curves for the different resistivities all coincide for small values of $x\sqrt{f}$, but differ for large values. A set of these curves is shown in Fig. 1.

Suppose that we place a search coil at different distances from an earth-return circuit carrying an alternating current. By measuring the current in the inducing circuit and the e.m.f. in the coil, the value of m can be determined. Values of m/\sqrt{f} plotted on logarithmic paper against values of $x\sqrt{f}$ will give a curve having the same shape as those just discussed. If we then superimpose on the test values a set of theoretical curves of m/\sqrt{f} against $x\sqrt{f}$ calculated for different values of resistivity, we shall find that one or other of the curves coincides with the test results. The resistivity for which this particular curve was calculated is then the value for the test site.

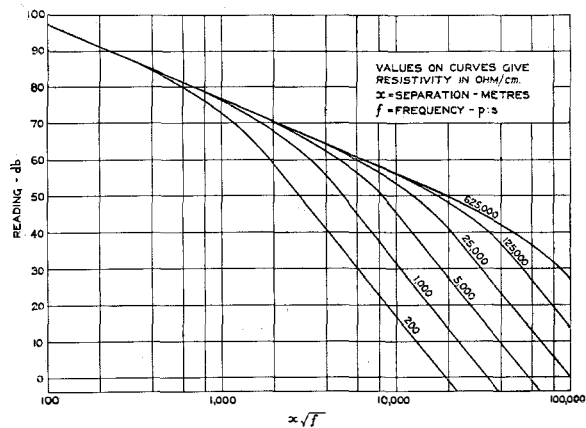

Figure 1—Curves for Determination of Earth Resistivity. (The values marked on the curves give the resistivity in ohm-cm.)

In practice it is possible to simplify the method by plotting the e.m.f. induced in the coil, instead of values of m/\sqrt{f} . Since the e.m.f. is proportional to m/\sqrt{f} , and logarithmic scales are used, the plotted values of e.m.f. will give a curve which has the same shape as the curve for m/\sqrt{f} except that all the points will be displaced by a constant amount along the vertical scale. By raising or lowering the experimental points by a constant amount the points for small values of $x\sqrt{f}$ can be made to fall along that part of the curve common to all resistivities. The points for larger values of $x\sqrt{f}$ will then fall along one or other of the family of curves, and the corresponding resistivity gives, as before, the value for the test site. This method of making the experimental points fit the theoretical curve not only renders it unnecessary to plot values of m/\sqrt{f} but also makes it unnecessary to know the value of the inducing current. Furthermore, it is unnecessary to know the absolute value of the induced e.m.f. provided readings can be obtained which are proportional to the e.m.f. This last fact remains that the number of turns in the coil and the mean area of a turn need not be known, and rather crude measuring apparatus can be used.

Application

In the practical application of this method the inducing circuit may consist of a special test conductor laid down for the purpose, or else an existing communication conductor or power conductor may be used. The conductor is earthed at

the far end and a voltage of known frequency is applied between the near end of the conductor and earth. A search coil is placed at various separations from the conductor and the e.m.f. induced in the coil is measured. A curve is plotted on logarithmic paper giving the e.m.f. against $x\sqrt{f}$, where x is the separation and f is the frequency of the test current.

A set of curves giving m/\sqrt{f} as a function of $x\sqrt{f}$ are plotted on transparent paper for different values of specific resistance. These curves are superimposed on the plotted test results so that the two $x\sqrt{f}$ scales coincide. The curves are then moved vertically up and down until the test results for small values of $x\sqrt{f}$ coincide with the common part of the curves. The test values for larger values of $x\sqrt{f}$ will then be found to coincide most nearly with one or other of the curves. The resistivity corresponding to this curve is then the required value.

Since the magnitude of the inducing current does not enter into the determination of the resistivity, it is possible to effect a considerable simplification in the method when a power circuit exists at the site. There are always higher harmonics of the zero phase-sequence group which flow along the conductors of the power line in parallel and return through the earth, and any one of these can be used for this test. The magnitude of the harmonic is, of course, unknown, but this is immaterial. The frequency must, however, be determined and this can be done by introducing a resonant circuit into the measuring device. The resonant circuit is tuned to the frequency of some convenient harmonic in the power circuit, and the settings of the capacitance and inductance give the frequency. The resonant circuit also serves to separate the

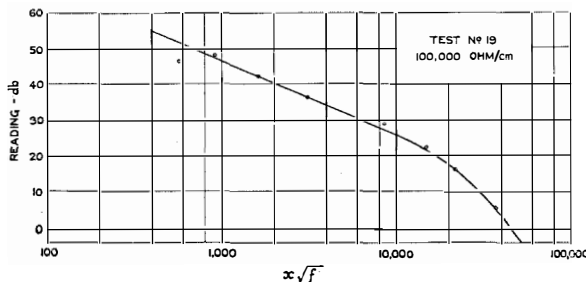

Figure 2—Results Obtained in Test on Earth of Resistivity 100,000 ohm-cm.

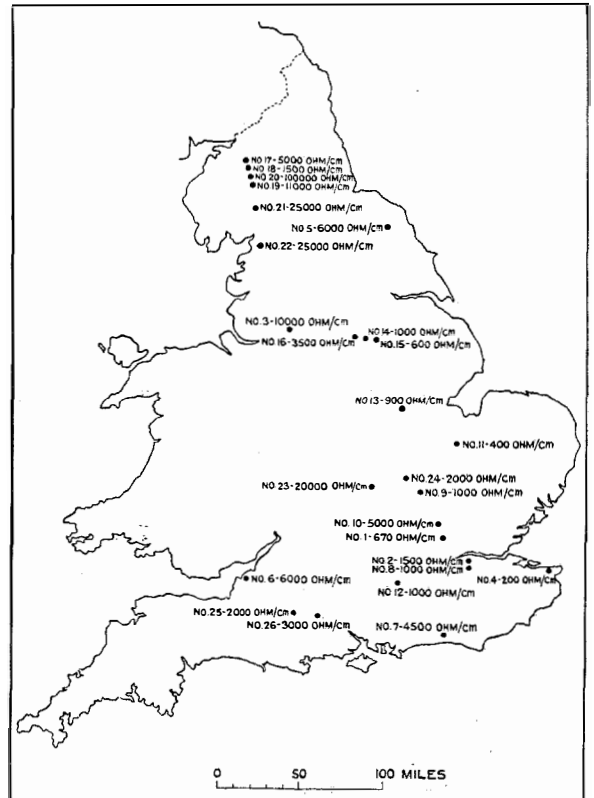

Figure 3—Earth-Resistivity Values. (The values are given in ohm-cm; the figures in brackets are the test numbers referred to in col. 1 of Table I.)

wanted harmonic from any others which may be present.

The apparatus as used by the author consists of a search coil having 300 turns wound on a square frame with sides of 35 cm. This is connected to a 4-stage amplifier having a maximum gain of about 100 decibels. A resonant circuit consisting of a variable condenser and a tapped inductance in series is connected between two of the stages. At the output of the amplifier is connected a measuring device, of which two types have been used. The first type consisted of a telephone receiver which could be connected either to the output of the amplifier or to a source of complex tone in series with an attenuator. The receiver is switched alternately from one to the other, and the attenuator is adjusted until it is estimated that the loudness of the test harmonic heard when the receiver is connected to the amplifier is the same as that of the attenuated complex tone. The amount of attenuation required, together with the gains of the amplifier,

is then a measure of the e.m.f. induced in the search coil. The advantage of this device is its sensitivity, the disadvantage being the fact that an accurate balance is not easy to obtain.

An alternative method is to connect an attenuator, rectifier, and d.c. meter, in series with the output of the amplifier. The attenuator is adjusted each time to give a standard deflection on the meter. The amount of attenuation, together with the gain of the amplifier, is a measure of the e.m.f. in the coil. This method is less sensitive than the former one but gives greater accuracy, and in practice it has been found sufficiently sensitive for most cases.

It will be clear from the theory that, since we are plotting the test values against $x\sqrt{f}$, the results obtained at different frequencies should all fall on the same theoretical curve. Since, however, we are plotting e.m.f. and not m/\sqrt{f} , and since the values of the inducing current at the different frequencies may not be the same, it

follows that the results at the different frequencies may have to be raised or lowered a different amount to obtain coincidence with the theoretical curve.

The method when carried out with the apparatus used by the author does not give a high degree of accuracy. For example, if a number of sites having a resistivity of 2,000 ohm-cm. were measured the results deduced from the curves would lie between about 1,500 and 3,000 ohm-cm. For other values of resistivity the same percentage error would apply. One factor tending to reduce the accuracy of the method is that, whereas the theory assumes the earth to be homogeneous, in some cases this is only approximately true. For the purpose for which these values are required, however, i.e., for calculating the voltages induced in communication circuits by neighbouring power lines, this accuracy is quite sufficient.

TABLE I.

Test No.	Date	Site	Resistivity, ohm-cm.	Geological Formation
(1)	16.12.31	Shenley, Herts	670	London clay
(2)	22.12.31	Eltham, London	1,500	Woolwich, Reading, and Oldhaven beds; clay, loam, sand
(3)	4.11.31	Trafford Park, Manchester	10,000	Bright red and mottled sandstones
(4)	20.12.27	Reculver, Kent	200	Alluvium
(5)	10.6.28	Goathland, Yorkshire	6,000	Inferior oolite (sandstone)
(6)	25.10.29	Weston-super-Mare, Somerset	6,000	Carboniferous limestone
(7)	2.1.32	Worthing, Sussex	4,500	Chalk
(8)	7.1.32	Eltham, London	1,000	As for Test No. 2
(9)	30.1.32	Chawston, Beds	1,000	Middle oolites, Oxford clay
(10)	3.2.32	Wheatthampstead, Herts	5,000	Chalk
(11)	6.2.32	March, Cambs	400	Alluvium
(12)	9.2.32	Milford, Surrey	1,000	Lower green sand
(13)	18.10.32	Somerby, Lincs	900	Lower oolites
(14)	18.10.32	Blyth, Notts	1,000	Bright red sandstone
(15)	19.10.32	Torworth, Notts	600	Hard pebbly sandstone and conglomerates
(16)	19.10.32	Bramley, Yorks	2,000-5,000	Coal-bearing measures
(17)	20.10.32	Southwaite, Cumberland	5,000	Sandstone
(18)	20.10.32	Plumpton Wall, Cumberland	1,500	Sandstone
(19)	21.10.32	Shap Wells, Westmorland	100,000	Contemporaneous andesites
(20)	21.10.32	Shap Common, Westmorland	11,000	Wenlock group (limestone and shales)
(21)	21.10.32	Watchgate, Westmorland	25,000	Kirby Moor flags
(22)	23.10.32	Burton, Westmorland	25,000	Carboniferous limestone
(23)	10.5.33	Wood Burcote, Beds	2,000	Great oolite (shelly limestone)
(24)	11.5.33	Sharnbrook, Beds	2,000	As for Test No. 27
(25)	25.9.34	Sutton Veny, Wilts	2,000	Lower greensand
(26)	27.9.34	Stapleford, Wilts	3,000	Chalk
(27)	7.3.32	Salerno, Italy	5,000	Sandstone
(28)	8.3.32	Near Salerno, Italy	5,000	Sandstone
(29)	9.3.32	Battipaglia, Italy	450	Clay
(30)	21.3.32	Cantinelle, Italy	11,000	Upper greensand over igneous rocks
(31)	30.3.33	Bussoleno, Italy	16,000	Limestone schist
(32)	29.3.33	Turin, Italy	500	Clay

Results Obtained

An example of the results obtained with this method is given in Fig. 2.

The method has been used by the author to obtain the specific resistance of the earth at various sites in England and Italy. The majority of these tests were made using the harmonics of a power line as the inducing current. Particulars of the test sites, resistivity, and geological formation are given in Table I.

The values of resistivity obtained in England have been plotted on a map (Fig. 3) in order to give an indication of the distribution in this country.

From the results given in Table I the summary shown in Table II has been obtained.

Conclusions

Experience extending over a number of years has shown that the search-coil method of measuring resistivity is quick and simple to carry out and gives results which are sufficiently accurate for use in problems of inductive interference. Comparison tests have been made³ with other methods of measuring the resistivity of the earth and the results show that the search-coil values

³W. G. Radley and S. Whitehead: *loc. cit.*

TABLE II

Geological Formation	Resistivity, ohm-cm
Alluvium.....	200-400
Clay.....	600-1,000
Coal-bearing measures.....	2,000-5,000
Chalk.....	4,000-5,000
Carboniferous limestone.....	5,000-6,000
Sandstone.....	6,000-10,000
Igneous rocks.....	50,000-100,000

are in reasonable agreement with values obtained with the other methods.

The search-coil method has the advantage that it measures the resistivity with the actual range of frequencies affecting the problem of induced noise. Its use is confined, of course, to cases where a power line, communication circuit, or other conductor, is available.

The very wide range of values obtained shows that it may be dangerous to assume a single value of resistivity for all sites, as has been done sometimes in the past, and indicates the need for resistivity measurements of this nature.

A few of the test values quoted here were obtained during tests in collaboration with the British Electrical and Allied Industries Research Association, and the remainder of the work is published with the permission of Standard Telephones and Cables, Ltd.

ERRATA

THE paper "The Manufacture and Uses of Metal Powders," by J. C. Chaston, published in the October, 1935 issue of *Electrical Communication* (page 139), contains the following statement:

"* * Very shortly after the discovery, in 1923, by Elmen and Arnold of the magnetic nickel-iron alloy known as 'Permalloy,' * * *"

The reference which was intended was to the first public scientific announcement of the discovery, made in this year to the Franklin Insti-

tute, the American Physical Society, and the National Academy of Sciences. The actual discovery was made some years earlier by Mr. G. W. Elmen, whose first United States patent application for Permalloy was filed in 1916.

The paper "The Design of 2-Pole Networks Containing One Positive and One Negative Reactance," by L. C. Pocock, published in the January, 1936 issue of *Electrical Communication*, page 207, Fig. 5: the inductance .0282H should read -.0282H.

Intermodulation in Loaded Telephone Cables[†]

By K. E. LATIMER, B.Sc.

Introduction

THE various phenomena attributable to the non-linearity of ferromagnetic loading materials at weak field strengths form a subject which has been studied by telephone engineers from different viewpoints for many years. The introduction of telephone repeaters and of composite telegraph apparatus, the occurrence of cases in which telephone cables are exposed to severe power interference, and the application of materials of high permeability to Krarup loaded submarine cables have caused the study of this question to assume some prominence from time to time.

Interest has been aroused once more by the possibility of appreciable intermodulation in the loading coils of long telephone circuits. If only a single communication channel is involved, this will result in a small reduction in articulation, but the effect will undoubtedly be more noticeable with the application of carrier systems, as the intermodulation products will then appear in the form of inter-channel crosstalk.

The possibility of considerable intermodulation effects on carrier systems is sufficiently serious to render opportune the demonstration of a simple theoretical treatment of the problem, and the preliminary discussion of some experimental results* obtained by A. R. A. Rendall upon an artificial cable in the laboratory. An opportunity occurred recently to gain some experience of intermodulation upon a loaded submarine cable to which a carrier telephone channel had been applied. This was of particular technical interest in that the cable was never intended for carrier telephone operation, the intermodulation effects consequently being only just within permissible limits; if the carrier telephone channel had been deliberately planned, the risk of not meeting guarantees with the design actually used would probably have been considered too great. Impulse telegraph currents were also present and naturally aggravated the intermodulation problem.

The Relation Between the Disturbing Effect of Speech and that of Pure Tone

The practical problem of determining in advance whether the intermodulation in a given system is likely to be excessive may be divided into three parts:

- (1) Determination of the third harmonic or major third order intermodulation e.m.f. induced in a loading coil or in a unit length of continuously loaded conductor when a current consisting of either one or two sinusoidal components is passed through it.
- (2) The summation of the harmonic or intermodulation powers received at the ends of the cable resulting from a series of the above e.m.f.'s. when the loading coils or elemental portions of loaded conductor are built up to form a loaded cable.
- (3) Correlation between the harmonic power due to a single sinusoidal current or the intermodulation power due to currents containing two sinusoidal components, and the noise received at the ends of the cable, resulting from the application of speech at a known level to one end.

The procedure thus depends on an assumption that there is some definite relationship between the inter-channel crosstalk measured with one or two single frequency tones, and that measured with speech. An attempt will be made to show to what extent this is approximately true, and the reasons governing the choice of one single frequency tone on some occasions, and two on others, will be briefly explained.

The general problem of determining inter-channel crosstalk when several carrier channels are applied to a common loading system is practically incapable of rigid solution, and, in fact, a number of very drastic simplifications must be made before a workable solution can be found. Some of these assumptions are only partially justifiable and the results obtained must therefore be used only after a comparison of the hypotheses with the data of the actual problem.

[†]Copies of this paper were presented to the delegates of the 3rd C.R. at the C.C.I.F. meeting held in London in February, 1936.

* The full account of these tests has not yet been published.

The first assumption is to neglect the crosstalk which arises from the interaction of two separate channels and which appears in a third channel. This is justified on account of the improbability of a period of high speech power occurring in both channels simultaneously.

Take the probability that conversation (of operators or subscribers) is in progress on a given line in the busy hour as 0.75.

The chance that this conversation, when it occurs, is proceeding at a given moment in a given direction, say, north-south, is obviously 0.5.

The chance of a syllable, as opposed to a short interval of silence between syllables (e.g., that which must always occur before a labial consonant can be pronounced) when conversation is in progress, is from oscillographic records about 0.5 (see Fig. 1).

Since the intermodulation voltage depends usually on the product of two currents, we are only interested in loud syllables. The chance that the syllable is a loud one, say that it contains one of the loud vowels or diphthongs in common use may, also on the oscillographic evidence of Fig. 1, be conservatively estimated at 0.5. The chance that the subscriber's loop has less than the median attenuation is, of course, 0.5. The compound probability of all these events occurring in the case of one channel is $0.75 \times 0.5 \times 0.5 \times 0.5 \times 0.5 = 0.047$, while that of their simultaneous occurrence on two given channels is 0.0022, from which one concludes that there is some justification for neglecting the coincidence unless the crosstalk from each channel acting alone is negligible, or the number of crosstalk combinations from two channels acting together is, say, more than ten times the number of combinations due to single channels.

When, however, one of the channels conveys signals of a more or less continuous character, such as telegraph, picture transmission, etc., or if a part of the carrier wave is transmitted, then the

type of crosstalk involving three channels may not be negligible.

Now, considering the type of crosstalk in which one channel alone produces the disturbance, the first point to be noticed is that for each type of third order crosstalk, one channel may produce disturbances in a band three times as wide as itself. Thus for a frequency band extending between frequencies f_1 and f_2 ,* the corresponding third harmonic band will extend from $3f_1$ to $3f_2$. Similarly the $2a+b$ and $2b+a$ products (i.e., those of frequency $(2f_a+f_b)$ and $(2f_b+f_a)$, f_a and f_b being arbitrary frequencies lying between f_1 and f_2), will each extend over the same range as the third harmonic, with which at the limits of the band they will be identical. The $2a-b$ and the $2b-a$ products will each extend over the range $2f_1-f_2$ to $2f_2-f_1$, again a band three times as wide as the original band which, however, it includes in its centre, so that the disturbance extends only to the two channels immediately adjacent to the disturbing channel, and within the disturbing channel itself.

One normally calculates ordinary crosstalk at single frequencies, justifying the application of these figures to represent speech crosstalk by reference to the resonant nature of the characteristics of microphones and receivers. The justification does not appear to be so great in the case of intermodulation crosstalk. Constructing a curve of output (in db) versus frequency for speech input for the microphone, one notes that the frequency scale is effectively multiplied by three when one considers the way in which the output will appear as intermodulation crosstalk in the disturbed circuit. As the intermodulation crosstalk currents will be dependent on the square of the disturbing currents, the output scale will be virtually multiplied by two when referred to the effect on the disturbed circuit. One concludes, therefore, that the effect of micro-

* A complete list of symbols will be found in the Appendix.

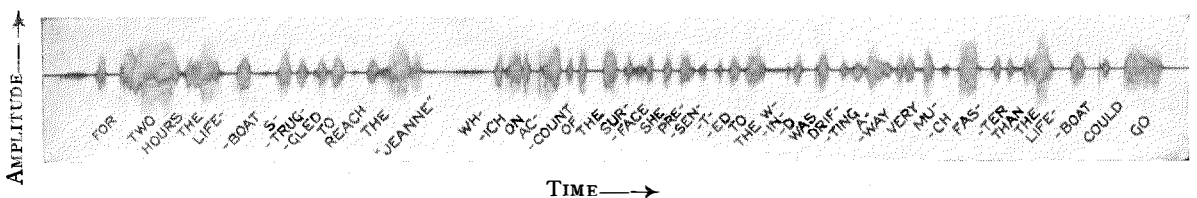

Figure 1—Oscillogram showing the Intervals of Silence between Speech Sounds and the Relative Amplitudes of Various Syllables. Duration of Sentence about 8 Seconds.

phone resonance is not so pronounced as in the case of ordinary crosstalk. In the most unfavourable case, when the microphone resonance on the disturbing circuit coincides with the receiver resonance on the disturbed circuit, the effect of the receiver resonance will be about the same as in the case of ordinary crosstalk. (The speech bands may be relatively inverted, but that will not make much difference.) This coincidence of resonances will frequently occur in the case of the third harmonic crosstalk of a single tone and the $2a+b$ and $2b+a$ components of two tones, but will seldom occur in the case of $2a-b$ and $2b-a$ components of two tones. In fact, bearing in mind that speech channels must be separated somewhat in frequency for filter design reasons, in order that a tone may be produced in about the middle of an adjacent channel by this type of intermodulation, the necessary two tones in the disturbing channel must be near the upper and lower limits of the band.

From the above arguments one may easily reach the following conclusions:

- (1) Crosstalk arising from the interaction of two disturbing speech channels can usually be neglected.
- (2) The representation of the noise in the disturbed circuit by a single tone is justified in the case of $2a+b$, $2b+a$, and third harmonic crosstalk to an extent somewhat less than is the case with ordinary crosstalk. In the case of $2a-b$ and $2b-a$ tones the representation is still less justified. No practicable alternative, however, seems possible and it seems reasonable to retain this simple idea, using sufficient caution.
- (3) The $2a+b$ and $2b+a$ components of two tones and the third harmonic of a single tone will be important in the same frequency range. As they will subsequently be shown to be closely allied manifestations of the same physical property of the loading material, it seems preferable to compare the speech crosstalk with the case involving the least calculation, namely, the third harmonic of a single tone.
- (4) The $2a-b$ and $2b-a$ components will appear within the disturbing speech channel and within those immediately adjacent to it.
- (5) For a given crosstalk in terms of single frequency tones, the $2a-b$ and $2b-a$ combinations will give less crosstalk when measured with speech than will the $2a+b$, $2b+a$, and third harmonic combinations, owing to the effects of microphone resonance and the improbability of occurrence of two strong tones of widely different frequencies as compared with that of a single strong tone or two closely spaced strong tones in the middle of the frequency band.

- (6) The presence of an uninterrupted series of signals on one or more channels in the cable may seriously upset some of the above conclusions.

“After-Effect”

Before proceeding to the determination of the third harmonic voltage in a loading coil or piece of continuously loaded conductor, there is a difficulty of fundamental nature which is worth consideration. One naturally accepts reluctantly any theory which does not explain all the observed facts: this has no doubt troubled many investigators who have studied the properties of ferromagnetic materials, for there has been a considerable amount of effort expended upon a point not yet satisfactorily explained, but otherwise of small practical interest. This is the property known as “after-effect” or “Nachwirkung.”* If it really exists (this is disputed in some quarters), the effect is observed as a small power loss, apparently in the ferromagnetic material, proportional to frequency and to the square of the magnetising current. A recent article by W. B. Ellwood† may be consulted for details of the latest speculations on this effect, and for tests which appear to indicate that even if it does exist, the conclusions drawn from E. Peterson’s theoretical work‡ are not upset. However, in view of the general lack of agreement on this question, it is worth while examining Peterson’s assumptions, for if they do not represent the truth satisfactorily, one cannot expect the conclusions to be correct.

These assumptions are as follows:

- (1) That the flux density is small.
- (2) That the frequency is low enough to enable the effects of eddy currents and other forms of magnetic lag (if they exist) to be neglected.
- (3) That the inducing field is sinusoidal, and that the hysteresis loop has consequently no auxiliary loops.
- (4) That the hysteresis loop branches are representable by double power series.
- (5) That when both “ h ” the instantaneous field, and H the maximum field are zero, the flux density in either branch is zero.

* “Die ferromagnetischen Konstanten für schwache Wechselfelder,” H. Jordan, *E.N.T.*, Band, 1 Heft, 1, p. 7, 1924.

† “Magnetic Hysteresis at Low Flux Densities,” *Physics*, Vol. 6, p. 215.

‡ “Harmonic Production in Ferromagnetic Materials at Low Frequencies and Low Flux Densities,” *Bell System Technical Journal*, Vol. VII, p. 762.

- (6) The flux density on one branch with H and h given is equal and opposite in sign to the flux density on the other branch corresponding to the negative of h and the same maximum field H .
- (7) The two branches corresponding to a definite H meet at the normal magnetisation curve.
- (8) That the magnetic circuit consists of a single closed circuit with only one circumferential field acting.

Of these (8) appears to be that immediately open to doubt, for the earth's field strength is certainly comparable with those field strengths for which the after-effect becomes noticeable.

This, however, does not explain the difficulty because, owing to the configuration of the magnetic circuit acted upon by the earth's field, the effective permeability is much smaller than for fields acting circumferentially. The results of such a reduction of permeability are well known from Peterson's work. Further, even if the bias due to the earth's field is taken into account, the after-effect still cannot be explained, for it does not depend upon assumption (6). However, as a matter of incidental interest, and to demonstrate that bias is present, the earth's field gives rise to second and other even harmonics of the flux, these components appearing at the consequent poles. They may be observed using the circuit of Fig. 2. The coil shown must naturally be one of the type in which each winding embraces only half the core. Something very like after-effect can, however, be produced if in addition to the earth's field a stray alternating field is present. It is therefore always desirable to put a magnetic shield around the specimen when making after-effect tests.

It seems so difficult to associate eddy currents as ordinarily understood, or magnetic lag of any kind, with a power loss varying as the first power of the frequency, that one is finally faced with this dilemma: either the a-c. method of measurement does not measure the area of the loop for some reason yet to be disclosed, or the assumption (4), innocent as it seems, is incorrect. It will be noted that two of the explanations mentioned by Ellwood, firstly, that the after-effect may be due to a combination of mechanical hysteresis and magnetostriction, and secondly, that it may be due to eddy currents produced by the Barkhausen effect, would probably invalidate (4).

Although we have thus concluded that Peterson's assumptions are to be viewed with some

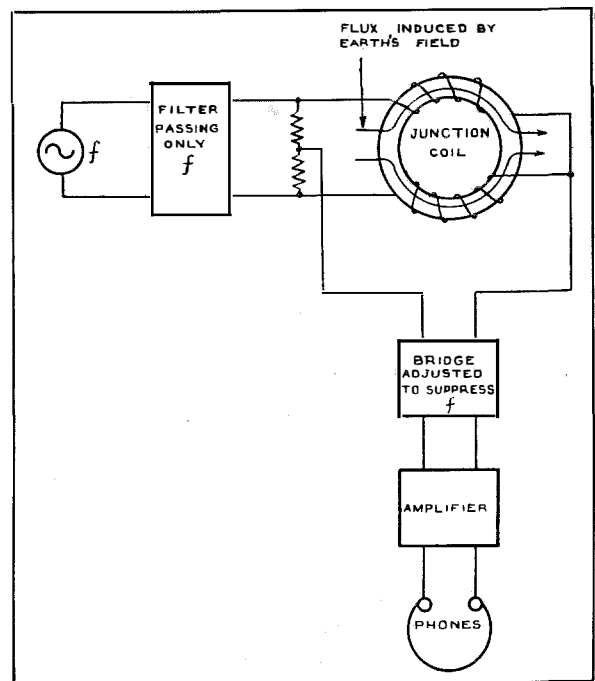

Figure 2—Even Harmonic Production in Loading Coils.

doubt, there seems to be no reasonable alternative course to take: this situation seems to occur too frequently when dealing with magnetic materials.

Harmonic E. M. F. Due to Single Sinusoidal Current

The flux wave produced in a core of ferromagnetic material when a sinusoidal field $H \cos pt$ is applied, is given by Peterson as:

$$B = b_1 \cos pt + a_1 \sin pt + b_3 \cos 3pt + a_3 \sin 3pt, \quad (1)$$

$$\text{where } a_1 = \frac{8H}{3\pi} (a_{02} |H| + \text{etc.}),$$

$$b_1 = H (a_{10} + a_{11}|H| + \text{etc.}),$$

$$a_3 = \frac{-8H}{15\pi} (a_{02} |H| + \text{etc.}).$$

b_3 is negligible for sufficiently small fields, and a_{02} , a_{10} , and a_{11} are constants of the material.

The expressions for a_1 , b_1 , and a_3 have been written in this somewhat unfamiliar form as the question of reversing the sign of H will arise at a later stage. Obviously, if this is done, the signs of all the coefficients must be reversed.

From this expression Peterson shows that the

third harmonic e.m.f. due to a sinusoidal magnetising current may be obtained using the following equation:

$$\bar{E}_h = 0.72 \times 10^{-8} \frac{a_{02} N^3 A f_a \bar{I}_a^2}{D^2} \equiv M \bar{I}_a^2, \quad (2)$$

where \bar{E}_h is the R.M.S. harmonic e.m.f.
 a_{02} is a constant of the material,
 N is the number of turns of wire linking the magnetic circuit,
 A is the cross-sectional area of the coil in cm.²,
 f_a is the frequency of the fundamental wave in periods per second,
 \bar{I}_a is the R.M.S. fundamental current in amperes flowing in the coil or piece of loaded conductor,
 D is the mean diameter of the magnetic circuit in cm.

Summation of Third Harmonic E.M.F's. in a Long Cable

Consider first a coil-loaded cable in which the propagation constants per unit length for the fundamental and third harmonic are

$$\gamma_a = \beta_a + j\alpha_a \text{ and } \gamma_h = \beta_h + j\alpha_h.$$

For a loading section of length l , the phase of the fundamental current will be rotated by $e^{-j\alpha_a l}$ and the square of the modulus will be reduced by $e^{-2\beta_a l}$. The phase of the third harmonic current will be rotated by three times that of the fundamental, so that (neglecting the effect of the first half section) the e.m.f. generated in successive loading coils by a mid load current \bar{I}_a at the sending end will be:

$$\begin{aligned} \bar{E}_h &= M \bar{I}_a^2 \text{ in the first coil,} \\ &= M \bar{I}_a^2 e^{-l(2\beta_a + 3j\alpha_a)} \text{ in the second,} \\ &= M \bar{I}_a^2 e^{-2l(2\beta_a + 3j\alpha_a)} \text{ in the third.} \end{aligned}$$

At each loading coil the above e.m.f. will act into an impedance $2Z_h$ (Z_h being the mid-load impedance at harmonic frequency) causing waves to be transmitted towards the sending and receiving ends of the circuit. The harmonic current will be multiplied by the factor $e^{-l(\beta_h + j\alpha_h)}$ for each loading section through which it passes.

Hence, at the receiving end of the circuit comprising n loading coils the total harmonic

current will be:

$$\bar{I}_h = M \bar{I}_a^2 e^{-(n-1)l(\beta_h + j\alpha_h)} (1 + e^{-l(2\beta_a - \beta_h + 3j\alpha_a - j\alpha_h)} + e^{-2l(2\beta_a - \beta_h + 3j\alpha_a - j\alpha_h)}) \text{ etc.} \dots \dots (3)$$

$$\therefore r \equiv \left| \frac{\bar{I}_h}{\bar{I}_a} \right| = \frac{M \bar{I}_a e^{-(n-1)\beta_h l}}{2 Z_h} \left[\frac{|1 - e^{-nl(2\beta_a - \beta_h + 3j\alpha_a - j\alpha_h)}|}{|1 - e^{-l(2\beta_a - \beta_h + 3j\alpha_a - j\alpha_h)}|} \right] \dots \dots (4)$$

Similarly for the sending end:

$$r = \frac{M \bar{I}_a}{2 Z_h} \left[\frac{|1 - e^{-nl(2\beta_a + \beta_h + 3j\alpha_a + j\alpha_h)}|}{|1 - e^{-l(2\beta_a + \beta_h + 3j\alpha_a + j\alpha_h)}|} \right] \dots \dots (5)$$

It will be noted that whereas (5) always represents the summation of a convergent series, the series appearing in (3) may be convergent, divergent, or indeterminate. If $2\beta_a < \beta_h$ the loading coils at the receiving end of the line will be responsible for the bulk of the intermodulation.

In general, however, the following simplifications are permissible:

In the case of (4) the numerator within the square brackets may be taken as unity if $2\beta_a > \beta_h$ and n is large. As $(2\beta_a - \beta_h + 3j\alpha_a - j\alpha_h)$ is always small compared with unity we may write:

$$r = \frac{M \bar{I}_a e^{-B_h}}{2 Z_h l} \left(\frac{1}{\sqrt{(2\beta_a - \beta_h)^2 + (3\alpha_a - \alpha_h)^2}} \right), \quad (4a)$$

where B_h is the overall attenuation in nepers at the frequency f_h .

If the phase distortion is small we may write:

$$r \leq \frac{M \bar{I}_a e^{-B_h}}{2 Z_h l (2\beta_a - \beta_h)} \dots \dots (4b)$$

Considering equation (5), the numerator within the square brackets may always be replaced by unity if n is large, and the attenuations in the denominator may nearly always be neglected in comparison with the phase constants. Consequently the following form may be used:

$$r = \frac{M \bar{I}_a}{2 Z_h} \frac{1}{2 \sin \left[\frac{(3\alpha_a + \alpha_h)}{2} l \right]} \dots \dots (5a)$$

It will be noticed that this result is independent of attenuation.

If $3\alpha_a = \alpha_h$, and if one may use the approximation $2 \sin\left(\frac{\theta}{2}\right) = \theta$, this becomes:

$$r = \frac{M \bar{I}_a}{12\alpha_a Z_h l} = \frac{M \bar{I}_a}{4\alpha_h Z_h l} \dots (5b)$$

If we are dealing with continuously loaded cables it is convenient to replace M by $m l$ where m is the value of M calculated for the magnetic circuit of a piece of conductor of unit length. The corresponding expressions for continuously loaded circuits will then be represented by the limits of the above relations when l approaches zero.

For the "far end" case, this will be:

$$r \leq \frac{m \bar{I}_a e^{-B_h}}{2 Z (2\beta_a - \beta_h)} \dots (6)$$

and for the "near end" case:

$$r = \frac{m \bar{I}_a}{12\alpha_a Z} = \frac{m \bar{I}_a}{4\alpha_h Z} \dots (7)$$

both these approximations being permissible in nearly all cases with continuously loaded cable. As the impedance will be constant with frequency, Z_h has been replaced by Z .

These expressions may be made more convenient by introducing the following relations:

$I_a = \sqrt{\frac{P}{Z_a}}$ where P is the power in watts transmitted into the line, and Z_a the mid-load impedance at fundamental frequency.

$$M = \frac{0.72 \times 10^{-8} a_{02} N^3 A f_a}{D^2}$$

$$= 0.6 F f_a = 0.2 F f_h$$

$$m = \frac{1.8 a_{02} f_a L_X}{\mu D} = \frac{0.6 a_{02} f_h L_X}{\mu D}$$

$$\left. \begin{aligned} Z &= \sqrt{\frac{L_T}{C}} \\ \alpha_a &= 2\pi f_a \sqrt{L_T C} \end{aligned} \right\} \text{for continuously loaded cable.}$$

f_h ≡ the frequency of the intermodulation product, in this case the third harmonic.

F ≡ coil hysteresis resistance in ohms per ampere hertz.

L_X ≡ added inductance in henries per unit length.

L_T ≡ total inductance in henries per unit length.

C ≡ capacity per unit length in farads.

R_h ≡ $20 \log_{10} \frac{1}{r}$, i.e., the level difference in db between the sent and received currents.

S_h ≡ $0.115 B_h$, the loss of the circuit in db at the third harmonic frequency.

In this way the following formulae are obtained:

COIL LOADED CABLE, FAR END

$$R_h \geq S_h + \frac{20 \log_{10} 10 Z_h l (2\beta_a - \beta_h) \sqrt{Z_a}}{F f_h \sqrt{P}} \dots (8)$$

$$F \geq \frac{10 Z_h l (2\beta_a - \beta_h)}{f_h} \sqrt{\frac{Z_a}{P 10^{(R_h - S_h)/10}}} \dots (9)$$

COIL LOADED CABLE, NEAR END

$$R_h = 20 \log_{10} \frac{20 \sin\left[\frac{(3\alpha_a + \alpha_h) l}{2}\right] Z_h \sqrt{\frac{Z_a}{P}}}{F f_h} \dots (10)$$

$$F = \frac{20 \sin\left[\frac{(3\alpha_a + \alpha_h) l}{2}\right] Z_h \sqrt{\frac{Z_a}{P 10^{R_h/10}}}}{f_h} \dots (11)$$

CONTINUOUSLY LOADED CABLE, FAR END

$$R_h \geq S_h + 20 \log_{10} \frac{3.33 Z (2\beta_a - \beta_h) \mu D \sqrt{\frac{Z}{P}}}{a_{02} f_h L_X} \dots (12)$$

$$a_{02} \geq \frac{3.33 Z (2\beta_a - \beta_h) \mu D \sqrt{\frac{Z}{P 10^{(R_h - S_h)/10}}}}{f_h L_X} \dots (13)$$

CONTINUOUSLY LOADED CABLE, NEAR END

$$R_h = 20 \log_{10} \frac{42 L_T \mu D \sqrt{\frac{Z}{P}}}{a_{02} L_X} \dots (14)$$

$$a_{02} = \frac{42 L_T \mu D \sqrt{\frac{Z}{P 10^{R_h/10}}}}{L_X} \dots (15)$$

An interesting point is the surprising simplicity of equations (14) and (15) which do not even involve the frequency. This independence of frequency is shared to some extent also by (10) and (11) if α_a is not too large.

Intermodulation E.M.F. Due to Two Sinusoidal Currents

The case of two or more single frequency tones was of growing importance as far back as 1931, when A. R. A. Rendall commenced an experimental investigation, the results of which it is hoped to publish in the near future. The author produced at that time a theoretical study of the application of two tones to a magnetic circuit, the conclusions of which proved to be in fair agreement with Rendall's experimental results. The formulae are also in substantial agreement with those recently published by R. M. Kalb and W. R. Bennett.* While their study is undoubtedly of wider application than that of the author, it is thought that the previous work may still be of some interest from the following two points of view:

- (1) That the treatment is somewhat simpler than that of Kalb and Bennett.
- (2) That by avoiding the assumption of Rayleigh's relation, conclusions of some technical interest are brought to light.

We take as our starting point equation (1) and assume further that it not only holds good for a steady sinusoidal field, but also for an oscillating field which is slowly increasing or decreasing in amplitude, H being in this case the envelope of the wave at any instant. This step really conflicts with the basis chosen by Peterson in that the field is no longer strictly sinusoidal, nor do the branches of the loops meet at the tips. The only argument which may be used to support this plausible course of action is that the end apparently justifies the means, for Rendall found that the results of this study were more or less corroborated by experiment.

The applied field is taken as $2 K \cos \omega t \cos pt$ where ω is small.

Now $2 K \cos \omega t \cos pt = K \{ \cos [(p+\omega)t] + \cos [(p-\omega)t] \}$ so that the field is made up of

*"Ferromagnetic Distortion of a Two Frequency Wave," *Bell System Technical Journal*, Vol. XIV, page 322.

two sinusoidal components of equal amplitude K and of frequencies not differing widely from each other. In substituting $2 K \cos \omega t$ for H , we see that the quantity H ($|H|$) is required in the form of a Fourier series.

Putting H ($|H|$) = $4 K^2 (c_1 \cos \omega t + c_3 \cos 3\omega t + \text{etc.})$ and evaluating the coefficients:

$$\pi c_1 = \int_{-\pi/2}^{\pi/2} \cos^2 \omega t \cos \omega t d(\omega t) - \int_{\pi/2}^{3\pi/2} \cos^2 \omega t \cos \omega t d(\omega t),$$

$$\pi c_3 = \int_{-\pi/2}^{\pi/2} \cos^2 \omega t \cos 3\omega t d(\omega t) - \int_{\pi/2}^{3\pi/2} \cos^2 \omega t \cos 3\omega t d(\omega t),$$

we find that:

$$H (|H|) = 4K^2 \left(\frac{8}{3\pi} \cos \omega t + \frac{8}{15\pi} \cos 3\omega t \right), \dots (16)$$

so that (1) becomes

$$B = 2a_{10}K \cos \omega t \cos pt + 4a_{11}K^2 \left(\frac{8}{3\pi} \cos \omega t \cos pt + \frac{8}{15\pi} \cos 3\omega t \cos pt \right) + 4a_{02} \frac{8}{3\pi} K^2 \left(\frac{8}{3\pi} \cos \omega t \sin pt + \frac{8}{15\pi} \cos 3\omega t \sin pt \right) - 4a_{02} \frac{8}{15\pi} K^2 \left(\frac{8}{3\pi} \cos \omega t \sin 3pt + \frac{8}{15\pi} \cos 3\omega t \sin 3pt \right) \dots (17)$$

Separating out these terms into the various sinusoidal components we have:

$$B = a_{10}K (\cos 2\pi f_a t + \cos 2\pi f_b t) + 2a_{11}K^2 \left(\frac{8}{3\pi} \cos 2\pi f_a t + \frac{8}{3\pi} \cos 2\pi f_b t + \frac{8}{15\pi} \cos 2\pi(2f_a - f_b)t + \frac{8}{15\pi} \cos 2\pi(f_a - 2f_b)t \right) + 2a_{02} \frac{8}{3\pi} K^2 \left(\frac{8}{3\pi} \sin 2\pi f_a t + \frac{8}{3\pi} \sin 2\pi f_b t + \frac{8}{15\pi} \sin 2\pi(2f_a - f_b)t - \frac{8}{15\pi} \sin 2\pi(f_a - 2f_b)t \right) - 2a_{02} \frac{8}{15\pi} K^2 \left(\frac{8}{3\pi} \sin 2\pi(2f_a + f_b)t + \frac{8}{3\pi} \sin 2\pi(f_a + 2f_b)t + \frac{8}{15\pi} \sin 2\pi(3f_a)t + \frac{8}{15\pi} \sin 2\pi(3f_b)t \right) \dots (18)$$

where $2\pi f_a = p + \omega$ and $2\pi f_b = p - \omega$.

This result is precisely the same as that deduced by Kalb and Bennett, with the exception that Rayleigh's relation has not been assumed above.

It will be noted that the $2a-b$ and $2b-a$ terms do not originate in the same way as the $2a+b$ and $2b+a$ terms. In the case of a coil to which a single sinusoidal field is applied, there are generated e.m.f.'s. at fundamental frequency which correspond to a change of inductance and resistance with current. When the sinusoidal field is modulated these e.m.f.'s. are also modulated, the "side-bands" so produced having frequencies $2a-b$ and $2b-a$.

The third harmonic due to a single sinusoidal field is also modulated when the field is modulated, and the side-bands in this case are the $2a+b$ and $2b+a$ terms, with third harmonic terms $3a$ and $3b$ appearing as by-products. Partly on account of this close association between $2a+b$ terms due to two tones and the third harmonic of a single tone, it is generally only necessary to consider the third harmonic for design purposes.

The same method was extended to the case in which one of the two sinusoidal components of the field is much larger in amplitude than the other. In this case the two waves are assumed to have angular velocities $p=2\pi f_a$ and $q=2\pi f_b$ and amplitudes P and Q where $\frac{Q}{P} = k$.

By simple trigonometry it may be shown that the amplitude of the wave at any moment is given by the following expression:

$$H = P\sqrt{1+k^2+2k \cos [(q-p)t]} \\ = P (1+k \cos [(q-p)t]) \text{ if } k \ll 1. \dots\dots (19)$$

Since H merely varies in magnitude but does not change sign, we may write:

$$H (|H|) = P^2 (1+k^2+2k \cos [(q-p)t]) \\ = P^2 (1+2k \cos [(q-p)t]) \text{ if } k \ll 1. (20)$$

It is not sufficient to insert this expression alone in equation (1), for the presence of the smaller sinusoidal component leads to a periodic phase shift of the compound wave. This phase shift is given by the expression:

$$\theta = \tan^{-1} \left\{ \frac{k \sin [(q-p)t]}{1+k \cos [(q-p)t]} \right\}.$$

If $k \ll 1$ this becomes

$$\theta = k \sin [(q-p)t] \dots\dots (21)$$

Another assumption is now introduced, namely, that if the angular velocity p is changing sufficiently gradually, equation (1) still represents correctly the flux wave for any momentary value of p .

Now making the above changes to equation (1) we have:

$$B = a_{10}P(1+k \cos [(q-p)t]) \cos [pt+k \sin (q-p)t] \\ + a_{11}P^2(1+2k \cos [(q-p)t]) \cos [pt+k \sin (q-p)t] \\ + \frac{8}{3\pi} a_{02} P^2 (1+2k \cos [(q-p)t]) \sin [pt \\ + k \sin (q-p)t] \\ - \frac{8}{15\pi} a_{02} P^2 (1+2k \cos [(q-p)t]) \sin [3pt \\ + 3k \sin (q-p)t] \dots\dots (22)$$

These terms will now be resolved into their various sinusoidal components. Neglecting the unimportant terms and making use of the approximation:

$$\left. \begin{matrix} \sin \theta = \theta \\ \cos \theta = 1 \end{matrix} \right\} \text{for } \theta \ll 1$$

the following result is obtained:

$$B = a_{10} P (\cos 2\pi f_a t + k \cos 2\pi f_b t) \\ + a_{11} P^2 (\cos 2\pi f_a t + \frac{3k}{2} \cos 2\pi f_b t) \\ + \frac{k}{2} \cos [2\pi(2f_a - f_b)t] \\ + \frac{8}{3\pi} a_{02} P^2 (\sin 2\pi f_a t + \frac{3k}{2} \sin 2\pi f_b t) \\ + \frac{k}{2} \sin [2\pi(2f_a - f_b)t] \\ - \frac{8}{15\pi} a_{02} P^2 (\sin 2\pi (3f_a)t) \\ + \frac{5k}{2} \sin [2\pi (2f_a + f_b)t] \\ - \frac{k}{2} \sin [2\pi (4f_a - f_b)t] \dots\dots (23)$$

This again agrees with the results given by Kalb and Bennett. The above expression includes only terms dependent upon P , Q , P^2 , and PQ . There is a fifth order term in this category. On

the other hand the terms in Q^2 have been excluded, for otherwise one must logically include a number of fifth and seventh order terms also dependent on Q^2 .

It is interesting to note the regrouping of the terms. The $(2p-q)$ components are allied with q components and both are associated with hysteresis resistance and change of inductance. The $(2p+q)$ and $(4p-q)$ terms are similarly interconnected and are associated with the third harmonic of p .

The above analysis applies, of course, also when the field having a frequency f_b is the greater, if Q is substituted for P , and if p and q are interchanged. k will then be defined as $\frac{P}{Q}$.

The cases intermediate between $k=1$ and $k \ll 1$ could be dealt with as for the case of $k \ll 1$ except that the simplification used in equations (19)–(23) no longer hold good. This gives every promise of tedious work without the reward of many interesting results. There is, however, one item of interest which could be extracted after much labour, the law of variation of the various

products when both sinusoidal fields have about the same amplitude and frequency, one of these fields being varied in amplitude and the other kept constant. This has been done by Kalb and Bennett, but they evidently did not consider it of sufficient importance to include in their summary of results. The partial derivatives of the amplitudes of the various intermodulation terms

with respect to k and κ (where $\kappa = \frac{Qq}{Pp}$) are rather small but not zero when both k and κ are about unity, and hence the amplitudes do not vary as P^2 , PQ , or Q^2 , but in accordance with other powers of P and Q when only one of these is varied.

It is useful to determine the ratio σ between the coefficients of equation (17) with those of equation (1) for equal power applied to the telephone circuit.

Putting $K = \frac{H}{\sqrt{2}}$ in equation (18) and assuming that Rayleigh's relation holds so that $a_{11} = 2a_{02}$ the following comparison of flux wave coefficients (moduli) is made:

	Relative Coefficient, σ	$20 \log_{10} \frac{1}{\sigma}$ db.
Third harmonic due to single frequency field.	1	0
$(2a+b)$ and $(2b+a)$ components of two frequency field.	$\frac{8}{3\pi} = .85$	- 1.4
$(2a-b)$ and $(2b-a)$ components of two frequency field.	$\sqrt{(2)^2 + \left(\frac{8}{3\pi}\right)^2} = 2.18$	+ 6.8
Third harmonics of two frequency field.	$\frac{8}{15\pi} = .17$	-15.4

Since $\bar{E}_h = NA \frac{dB}{dt} \times 10^{-8}$, each of these coefficients will be multiplied by a frequency factor in the corresponding voltage wave.

Naturally if a_{11} is not equal to $2a_{02}$, which may easily happen, the ratio 2.18 will be incorrect. It may easily be higher than 3.

Summation of Intermodulation E.M.F's. in a Long Cable

In order to perform the summation of e.m.f's. for the case of a two frequency field, it is proposed to assume that there is no phase or attenuation distortion as regards the two fundamental tones. This assumption is usually permissible as

the two frequencies will not differ from one another by more than 2,000 p:s, i.e., they will both be in the same speech channel, whereas in the circumstances in which intermodulation is of interest the cable must pass a band width of 6,000 p:s or more. We have then the following relations:

$$\beta_a = \beta_b$$

$$\frac{\alpha_a}{f_a} = \frac{\alpha_b}{f_b}$$

It will also be assumed that:

$$Z_a = Z_b$$

As before the squares of the two fundamental waves will be attenuated by $e^{-2\beta_s l}$ per loading section and their phases will be rotated by

$e^{-j\alpha_a l}$ and $e^{-j\alpha_h l}$, respectively. The corresponding phase rotation of the intermodulation product due to phase rotation of the fundamentals will be $e^{-j\alpha_a (fh/fa)l} = e^{-j\alpha_h (fh/fb)l}$ per loading section. The intermodulation product will be further attenuated by $e^{-\beta_h l}$ and its phase rotated by $e^{-j\alpha_h l}$ per loading section.

In this way we obtain the following equations which are analogous to (4a), (4b), (5a), (5b), (6), and (7), respectively:

$$r = \frac{M \bar{I}_{a+b} e^{-B_h}}{2 Z_h l} \frac{1}{\sqrt{(2\beta_a - \beta_h)^2 + (\rho\alpha_a - \alpha_h)^2}}, \dots (4c)$$

$$r \leq \frac{M \bar{I}_{a+b} e^{-B_h}}{2 Z_h l (2\beta_a - \beta_h)}, \dots (4d)$$

$$r = \frac{M \bar{I}_{a+b}}{2 Z_h} \frac{1}{2 \sin \left[\frac{(\rho\alpha_a + \alpha_h) l}{2} \right]}, \dots (5c)$$

$$r = \frac{M \bar{I}_{a+b}}{4 \rho \alpha_a Z_h l} = \frac{M \bar{I}_{a+b}}{4 \alpha_h Z_h l}, \dots (5d)$$

$$r \leq \frac{m \bar{I}_{a+b} e^{-B_h}}{2 Z (2\beta_a - \beta_h)}, \dots (6a)$$

$$r = \frac{m \bar{I}_{a+b}}{4 \rho \alpha_a Z} = \frac{m \bar{I}_{a+b}}{4 \alpha_h Z}, \dots (6b)$$

Here:

$$\bar{I}_{a+b} = \sqrt{2} \bar{I}_a = \sqrt{2} \bar{I}_b,$$

$$\rho = \frac{f_h}{f_a}.$$

Putting $\bar{I}_{a+b} = \sqrt{\frac{P}{Z_a}}$,

$$M = 0.2 \sigma F f_h,$$

$$m = \frac{0.6 \sigma a_{02} f_h L_X}{\mu D},$$

- $\sigma = .85$ for $2a + b$ and $2b + a$ products,
- $= 2.18$ for $2a - b$ and $2b - a$ products,
- $= 1$ for the third harmonic of a single frequency,

the following equations are obtained. These are merely the generalised forms of which equations (8)—(15) are special cases, as may be seen by putting $\rho = 3, \sigma = 1$.

COIL LOADED CABLE, FAR END

$$R_h \geq S_h + 20 \log_{10} \frac{10 Z_h l (2\beta_a - \beta_h) \sqrt{Z_a}}{\sigma F f_h \sqrt{P}} \dots (8a)$$

$$F \geq \frac{10 Z_h l (2\beta_a - \beta_h)}{\sigma f_h} \sqrt{\frac{Z_a}{P 10^{(R_h - S_h)/10}}} \dots (9a)$$

COIL LOADED CABLE, NEAR END

$$R_h = 20 \log_{10} \frac{20 \sin \left[\frac{(\rho\alpha_a + \alpha_h) l}{2} \right] Z_h}{\sigma F f_h} \sqrt{\frac{Z_a}{P}} \dots (10a)$$

$$F = \frac{20 \sin \left[\frac{(\rho\alpha_a + \alpha_h) l}{2} \right] Z_h}{\sigma f_h} \sqrt{\frac{Z_a}{P 10^{(R_h/10)}}} \dots (11a)$$

CONTINUOUSLY LOADED CABLE, FAR END

$$R_h \geq S_h + 20 \log_{10} \frac{3.33 Z (2\beta_a - \beta_h) \mu D}{\sigma a_{02} f_h L_X} \sqrt{\frac{Z}{P}} \dots (12a)$$

$$a_{02} \geq \frac{3.33 Z (2\beta_a - \beta_h) \mu D}{\sigma f_h L_X} \sqrt{\frac{Z}{P 10^{(R_h - S_h)/10}}} \dots (13a)$$

CONTINUOUSLY LOADED CABLE, NEAR END

$$R_h = 20 \log_{10} \frac{42 L_T \mu D}{\sigma a_{02} L_X} \sqrt{\frac{Z}{P}} \dots (14a)$$

$$a_{02} = \frac{42 L_T \mu D}{\sigma L_X} \sqrt{\frac{Z}{P 10^{(R_h/10)}}} \dots (15a)$$

Summation of the Noise Due to Successive Repeater Sections

After what has been said about the addition of harmonic or intermodulation products in successive loading sections, there is little extra difficulty in applying the results to the corresponding problem in terms of repeater sections, but some rather interesting points are brought to light.

As regards near end intermodulation the noises due to successive repeater sections may, owing to the large relative phase shift, be assumed to have random angle but correlated magnitude. Under these circumstances the average noise

energy will be the sum of the noise energies of individual repeater sections, taking account of the appropriate losses and gains. The probability of obtaining a given noise on one particular job may be calculated by known methods.* In the case of far end intermodulation upon a long system in which all repeater sections and repeaters are similar and in which each section is equalised at the repeater which follows it, it is obvious that the overall noise depends, sometimes critically, upon the phase distortion. In a continuously loaded cable the phase distortion may be negligible and the noise for n_r repeater sections will be n_r times the noise for one section, a dangerous result. The same thing will happen if each separate repeater section of a coil loaded cable is phase compensated but not if the phase compensation is lumped at the terminals.

If there is no phase compensation, or if it is lumped at the terminals, the noise due to each repeater section is added to that due to the preceding repeater section at an angle $(\rho\alpha_a - \alpha_h)nl$. This angle may certainly vary from 0.1 to 5.0 radians, and may in special cases be zero owing to the phase distortion of the repeater†. The summation for n_r repeater sections is then:

$$\Psi_o = \Psi_r \left| \frac{\sin\left(\frac{n_r\alpha}{2}\right)}{\sin\left(\frac{\alpha}{2}\right)} \right|,$$

where Ψ_o is the overall noise in mV

Ψ_r is the noise per repeater section in mV,
and $\alpha = (\rho\alpha_a - \alpha_h)nl$.

(The connection between the Ψ 's and R_h will be explained subsequently.)

Now $n_r\alpha$ is an angle in the order of 10 to 500 radians for 100 repeater sections, so that the noise will vary in a periodic manner with the length of the circuit. As we are interested in the maximum noise likely to be obtained, and as the value of $\sin\left(\frac{n_r\alpha}{2}\right)$ must be between ± 1 , we may dispose of questions of probability by taking its value as 1.

* *Bell System Technical Journal*, Vol. XII, page 25, and bibliography therein.

† *Bell System Technical Journal*, Vol. IX, page 586.

$\sin\frac{\alpha}{2}$ may have the value ± 1 , so that $\Psi_o = \Psi_r$, or the overall noise is equal to the noise per repeater section, a rather surprising result which indicates that the noise measured on a repeater section gives no indication of the overall noise unless the phase distortion is known. When $\sin\frac{\alpha}{2} = \pm 1$ the intermodulation measured with steady tones may give a very inaccurate picture of the situation.

In order that one may obtain a rough idea of the part which phase distortion plays, the following approximate formulae will be introduced:

$$\alpha_a l = 2 \sin^{-1} \left(\frac{f_a}{f_o} \right)$$

$$\alpha_h l = 2 \sin^{-1} \left(\frac{f_h}{f_o} \right),$$

f_o being the cut-off frequency of the circuit.

Whence $(\rho\alpha_a - \alpha_h)l = \frac{2f_h}{f_o} \times$

$$\left[\frac{\sin^{-1}\left(\frac{f_a}{f_o}\right)}{\frac{f_a}{f_o}} - \frac{\sin^{-1}\left(\frac{f_h}{f_o}\right)}{\frac{f_h}{f_o}} \right],$$

Expanding the inverse sines, when f_a and f_h are small compared with f_o :

$$(\rho\alpha_a - \alpha_h)l = \frac{f_h}{3f_o} \left[\left(\frac{f_a}{f_o}\right)^2 - \left(\frac{f_h}{f_o}\right)^2 \right].$$

If ρ is constant, as for third harmonic production, this expression is proportional to f_h^3 whereas if there is a fixed frequency separation as in $2a-b$ products, it is proportional to f_h^2 . Thus although Ψ_r is proportional to f_h , Ψ_o towards the lower frequencies varies as $\frac{1}{f_h}$ or $\frac{1}{f_h^2}$, again a rather surprising result. This is only to be taken as a rough indication, for obviously phase distortion due to causes other than lumpiness of loading will play its part: also if the phase distortion approaches zero, the finite number of repeater sections must be taken into account.

Experimental Determination of Intermodulation Voltages on a Coil Loaded Artificial Cable

A series of measurements of intermodulation products was made by Rendall upon an artificial line comprising 44 mH loading coils, the loading sections of cable being represented by H networks each containing four resistances and a condenser. The whole line approximated in all its characteristics to a repeater section of extra light loaded cable. These tests were of a very extensive nature and include determinations of third and fifth order terms, the fundamentals consisting of one, two, or three tones. The full

discussion of the results cannot be attempted here, but they indicate a fairly satisfactory agreement with the theoretical expectations, as the following example will show.

The far end third harmonic readings both on the whole line and upon a portion of it, were found to agree with the calculated values within ± 2 db, the average error of six independent determinations being 0.8 db, the measured amplitude being generally the greater.

The value of σ was determined by comparing the intermodulation measurements with the third harmonic measurements by reference to equation (8a). The results were as follows:

GROUPS OF FOUR COMBINATIONS OF PRODUCTS OF TYPE $2a+b$

Group of Fundamental Frequencies, H_z .	$20 \log_{10} \frac{1}{\sigma}$, db.		Maximum departure from average of group, db.
	Calculated.	Measured.	
900 } 1050 } 1270 }	-1.4	-3.2	1.1
750 } 1050 } 1370 }	-1.4	-2.5	2.7

GROUPS OF SIX COMBINATIONS OF PRODUCTS OF TYPE $2a-b$

Group of Fundamental Frequencies, H_z .	$20 \log_{10} \frac{1}{\sigma}$, db.		Maximum departure from average of group, db.
	Calculated.	Measured.	
900 } 1050 } 1270 }	+6.8	+5.3	1.2
750 } 1050 } 1370 }	+6.8	+4.6	4.3
1600 } 1870 } 2170 }	+6.8	+5.4	3.8

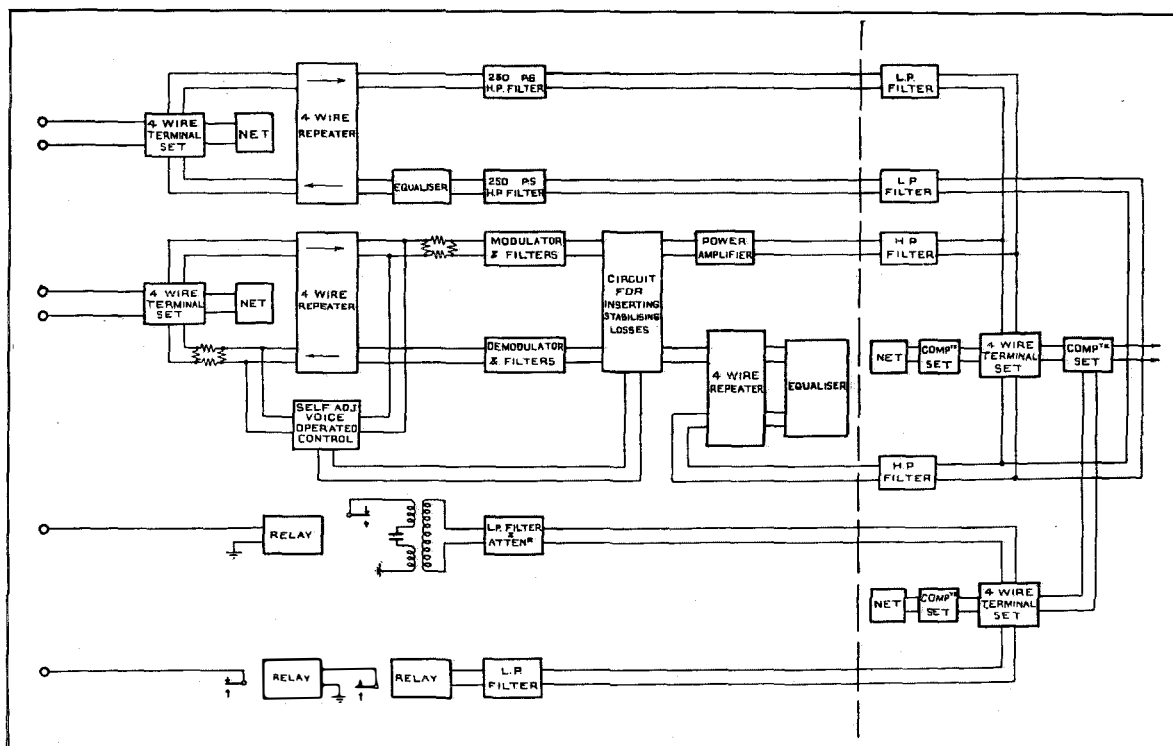

Figure 3—Block Schematic Italy-Sardinia System

As a matter of interest, the products of type $2a+b$ and $a+b+c$ were found to have the same value of σ within experimental error, and similarly $2a-b$ and $a+b-c$ have the same value of σ . The above summary includes one product of the $a+b+c$ type in each of the first two groups and two products of the $a+b-c$ type in each of the last three. The apparent observational error was greatest in those cases where the fundamentals were most widely spaced: the assumptions that $\beta_a = \beta_b$ and that $\frac{\alpha_a}{f_a} = \frac{\alpha_b}{f_b}$ under these circumstances depart appreciably from the truth.

While the results obtained by Rendall in the case of the third harmonic of one tone, when two tones of equal amplitude were applied, were sometimes in agreement with the value for $\sigma = \frac{8}{15\pi}$, the apparent observational error was at times so large as to suggest that some other effect was present. For instance, it was found that the magnitude of the third harmonic when

two tones were present, was very dependent on the frequencies of these tones.

Observations of Intermodulation on Continuously Loaded Cable

Intermodulation effects were encountered to an appreciable extent on the Italy-Sardinia cable when the carrier telephone was added. Technical details of the cable itself and of the voice frequency equipment have been published,* the proposal mentioned at that time to establish a carrier telephone circuit having been subsequently accomplished in January, 1935. There has been no publication yet dealing with the carrier channel, and so a very brief description of the system may be of interest. The general lay-out of the system is shown in Fig. 3. It will be seen that self-adjusting anti-singing equipment was provided, no technical operator being

* "The New Italy-Sardinia Telephone Circuit," A. G. Pession, and "The Reduction of Impedance Irregularities in Submarine Cable Circuits by Allocation," C. Tonini, R. L. Hughes, and K. E. Latimer, *Electrical Communication*, October, 1933 and January, 1934, respectively.

required, but in other respects the carrier channel followed the general lay-out of the voice frequency and telegraph circuits, the connections between the repeater stations and cable huts being made by separate four-wire circuits* and the voice, carrier, and telegraph circuits being combined at the cable huts. In this way intermodulation was confined as far as possible to the submarine cable itself, that resulting from the use of terminating sets common to voice and carrier channels being negligible as it is attenuated by the singing point before it can reach the receiving circuit.

As might be expected from an inspection of Fig. 3, only the near end type of intermodulation proved to be serious.

The loss-frequency curve of the cable and the frequency allocation of the various channels are given in Fig. 4.

The value of a_{02} was estimated from measurements of impedance change with current and found to be about 13.7. Using this value in equation (14a) together with the following other constants:

$$\begin{aligned} L_T &= 4.2 \times 10^{-3} H & D &= .4 \text{ cm.} \\ L_X &= 3.7 \times 10^{-3} H & Z &= 114 \text{ ohm.} \\ \mu &= 100 & P &= .001 \text{ watt.} \\ & & \sigma &= 1 \end{aligned}$$

gives $R_H = 93.4$ db.

This result was thought to be so serious that experimental carrier equipment was applied to the cable in order to ascertain, before the manufacture of permanent equipment was commenced, that the crosstalk due to speech would be within permissible limits.

The results of some measurements made from the repeater stations using the experimental equipment are compared in Fig. 5 with the calculated value of R_H (curve *a*) for $\sigma = 1$. The variable is P expressed in db with respect to 1mW. Curves (b)–(f) are the results of a series of independent determinations of the third harmonics of single tones, either 1400 or 1500 p/s, while (k) refers to the 2000 p/s product of two equal tones of 3500 and 5000 p/s.

The series of curves for the third harmonic indicate that all the readings lie within a range of ± 4 db. Some of this error of observation

* Brit. Patent 364,569.

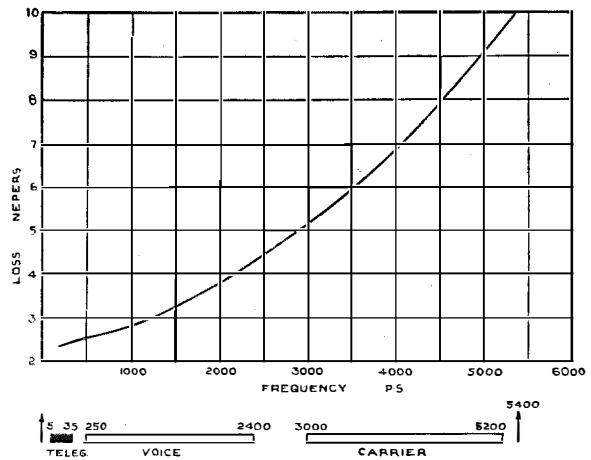

Figure 4—Loss and Frequency Allocation of Italy-Sardinia Cable

arose from the fact that when the repeaters were fully loaded the intermodulation products were only a small amount above the noise level. Considering that the losses and gains of a large amount of equipment entered into the measurements, the agreement with theoretical expectations is fairly satisfactory.

While the above tests were in progress the telegraph circuit which had not been required for traffic for some days, was suddenly put into continuous service for a long period. The effect upon the readings of intermodulation was rather remarkable. Curves (g) and (h) are comparable with (b)–(f), and (l) with (k). It will be noted that over a certain range the measured value of R_H is substantially constant. The reason for this is that the intermodulation products change their character, the telegraph current playing the role of the tone of greater amplitude. Seeing that the current delivered as intermodulation product is proportional to the square of the amplitude of the tone applied to the speech channels and not to the cube, this current must be derived from a hysteresis term of the after-effect type. A term of this nature appears in equation (23),

$$\frac{8}{3\pi} a_{02} P^2 \frac{3k}{2} \sin 2\pi f_b t.$$

When one listens to the product of intermodulation under these conditions, it is heard as a tone varying greatly in amplitude, being say 10–20 db stronger at the moment when a signal

is transmitted than during the intervals between signals. The telegraph noise and its own harmonics are inaudible, only its effect upon other tones being heard.

Empirical Rules for Estimating the Crosstalk Due to Speech

The crosstalk heard under service conditions is not only unintelligible but of such a character that one can only be persuaded with some difficulty that it was ever originated by human speech. Under these circumstances the logical course is to treat the crosstalk as a noise. A comparison between the noise observed on the Italy-Sardinia cable and the loss measurements made with single or two frequency tone leads one to the following empirical rules.

Let the third harmonic or intermodulation tone measured at a given receiving point be R_h db below 1 mW when 1 mW of one tone or of two tones having equal amplitude, is sent into the system at a given sending point. Then the noise measured at the receiving point when the sending point is connected to a subscriber's telephone and normal conditions of conversation are set up, will be:

$$\left. \begin{aligned} \Psi &= 2 \times 10^{(R_h - R'_h)/20} \text{ millivolts according to C.C.I.F. definition of noise,} \\ \psi &= 200 \times 10^{(R_h - R'_h)/20} \text{ noise units,} \end{aligned} \right\} (24)$$

where R'_h has the value 60 db for third harmonic crosstalk and 40 db for $2a - b$ crosstalk. (The fact that $2a - b$ crosstalk was also present when the third harmonic crosstalk was measured is thus unimportant.) These rules naturally apply strictly only to the Italy-Sardinia cable, and in other cases other values of R'_h must be estimated in some way. Some research work in this direction is required, but in the absence of definite knowledge, a rather makeshift method of estimation has to be adopted, of which a numerical example will be given.

The fundamental frequencies which were used in estimating R'_h in (24) on the Italy-Sardinia cable were 1400 p/s for voice-carrier and 3500 and 5000 p/s for carrier-voice. Different representative frequencies may have to be adopted in other cases.

The above formulæ might possibly also become

unreliable for noise values very different from those encountered on the Italy-Sardinia cable by reason of threshold effects. The noise actually measured was in the region of 200 units or 2 mV, it being just possible to adjust the levels of voice and carrier channels so as to obtain this figure under service conditions. The noise was measured by aural comparison with a noise standard buzzer, no amplification being provided in the set. The quality of the noise heard on one channel when conversation was in progress on the other, was different according to whether the telegraph circuit was in operation or not, but the difference was not sufficiently great to be able to assign an increase in the disturbing effect.

Example of Use of Design Formulae

Take the hypothetical case of a cable system having an attenuation frequency curve and channel allocation shown in Fig. 6, the circuit consisting of a 1.4 mm pair loaded with 3.2 mH coils on a 1.83 km spacing, the cut-off frequency being 20,000 p/s and the impedance 270 ohms. The sending level of each channel will be assumed to be +0.5 nepers. We are only concerned with far end intermodulation, and the circuits have

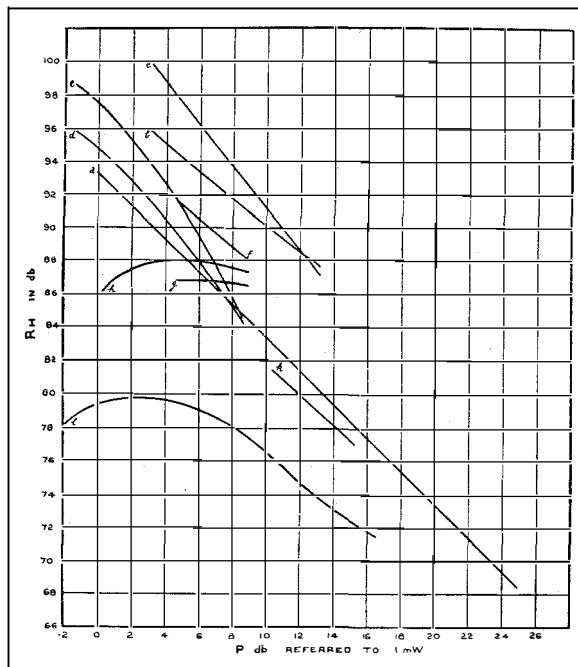

Figure 5—Modulation on Italy-Sardinia Cable

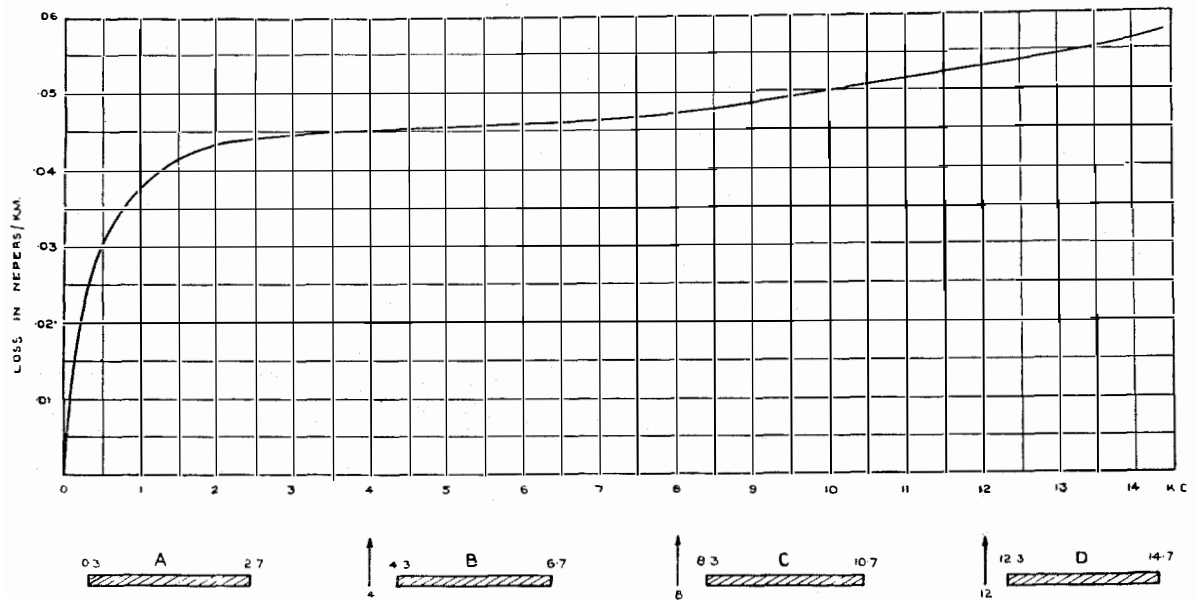

Figure 6—Loss and Frequency Allocation for "World Pair"

to be available for distances up to 10,000 km, say 125 repeater sections of 80 km. Phase compensation is assumed to be absent or applied only at the terminals.

This case differs so much from that of the Italy-Sardinia cable that little more than a rough estimate may be made of the crosstalk due to speech, consequently the predictions may not agree very well with actual measurements.

Considering the various types of crosstalk, the combinations of Table I are noted. This is clearly a case where only the products due to one channel acting alone need be considered.

The relative severity of the third harmonic crosstalks may be roughly estimated from the frequencies involved. For this purpose reference may be made to Fig. 7, of which the curve marked "transmitter" gives the distribution of speech energy allowing for the distortion of a particular typical microphone.* The ordinates have been doubled as already explained, but the frequency scale is normal. The curve marked "receiver" gives the relative interfering effects of various tones as heard through a commercial receiver. One sees that the Italy-Sardinia case was about

the most severe likely to be encountered, as 1400 p:s applied to the voice channel gives rise to 4200 p:s (1200 p:s when demodulated) in the carrier channel. In the hypothetical case,

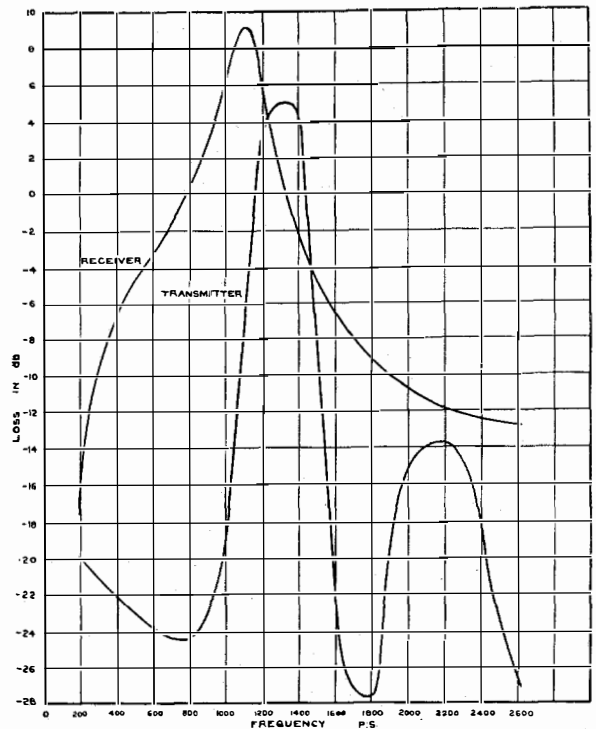

Figure 7—Curves Used for Estimating R'_k

* For typical characteristics of microphones see P.O. E.E.J., Vol. XXVIII, page 167.

product 5 would probably be worst for a tone of 1500 p:s in the voice channel giving 500 p:s when demodulated in channel B, and product 4 would be worst for 400 p:s sent into channel B and received as 1200 p:s in channel D. Both these products would be greatly dependent on the particular telephones used, but 50 db and 40 db, respectively, could safely be allowed for R'_h . By a similar system of rough estimation a value of $R'_h=35$ db in respect of the $2a-b$ products may be considered safe. The representative received frequencies may be considered to be 2400 p:s for products 1, 6 and 10, and 700 p:s for 9 and 15.

Since the loss of each repeater section may be assumed to be neutralised by the succeeding

repeater, S_h may be taken as zero and the value of R_h so obtained will be that between the repeater output on the disturbing circuit and the repeater output on the disturbed circuit at the next repeater station. If the overall losses of the circuits are zero, the value of R_h so obtained will apply also to the contribution of that repeater section to the crosstalk measured between two overall circuits provided that the correct value of P is used.

Putting $P = .0027$ watts (.5 neper above 1 mW).

$Z_a = Z_h = 270$ ohms.

$l = 1.83$ Km.

TABLE I

Product No.	Disturbed Channel	Disturbing Channel	Type of Crosstalk	Frequency Range of Crosstalk, p : s
1	A	B	$2a-b$	1,900 - 2,700
2	A	B & C	$2a-b$	300 - 2,700
3	A	B & D	$2a-b$	300 - 2,100
4	A	C & D	$2a-b$	300 - 2,700
5	B	A	$3a$	300 - 1,100
6	B	C	$2a-b$	1,900 - 2,700
7	B	A & C	$2a-b$	4,300 - 6,700
8	B	C & D	$2a-b$	5,900 - 6,700
9	C	B	$2a-b$	4,300 - 6,700
10	C	D	$2a-b$	8,300 - 9,100
11	C	A & B	$2a+b$	9,900 - 10,700
12	C	A & B	$2a-b$	8,900 - 10,700
13	C	A & D	$2a-b$	8,300 - 10,700
14	D	B	$3a$	8,300 - 10,700
15	D	C	$2a-b$	12,900 - 14,700
16	D	A & B	$2a+b$	12,300 - 13,100
17	D	A & B	$2a-b$	12,300 - 14,700
18	D	A & C	$2a+b$	12,300 - 13,100
19	D	A & C	$2a-b$	12,300 - 14,700
20	D	B & C	$2a-b$	13,900 - 14,700

TABLE II

(1)	(2)	(3)	(4)	(5)	(6)	(7)	(8)	(9)	(10)	(11)	(12)
Product No.	Type	σ	f_a	f_h	β_a	β_h	ρ	$2\beta_a - \beta_h$	$\rho\alpha_a - \alpha_h$	$\sqrt{(9)^2 + (10)^2}$	R'_h
1	$2a-b$	2.18	5000	2400	.046	.043	.48	.049	.00114	.049	35
5	$3a$	1	1500	4500	.040	.045	3	.035	.00185	.035	50
6	$2a-b$	2.18	9000	6400	.048	.047	.7111	.049	.00685	.049	35
9	$2a-b$	2.18	5000	8800	.046	.048	1.76	.044	.01165	.046	35
10	$2a-b$	2.18	13000	10400	.054	.050	.8	.058	.02098	.062	35
14	$3a$	1	4400	13200	.045	.054	3	.036	.06052	.070	40
15	$2a-b$	2.18	9000	12800	.048	.054	1.4222	.042	.03348	.054	35

The other constants for the various intermodulation products are given in Table II. It will be seen that in the case of the higher channels the phase distortion is not negligible. The figures in column (11) are therefore used instead of those in column (9) in formula 8a.

TABLE III

Product	Disturbed Channel	Noise per Repeater Section, Ψ_r , mV	Overall Noise Ψ_o , mV
1	A	7.7 F	169 F
5	B	52 F	705 F
6	B	20.5 F	76 F
9	C	30 F	67 F
10	C	26.3 F	35 F
14	D	24.2 F	37 F
15	D	37.2 F	38 F

From these figures the results in Table III have been calculated. It is noticed that the worst noise is to be expected towards the lowest frequencies, as already anticipated. As other sources of noise may also be present in this range, one cannot allow much noise for intermodulation. Intermodulation is also to be expected from repeaters and possibly from other apparatus. It is beyond the scope of this paper to determine what limits should be observed for noise. In order to illustrate the design problem, let it be assumed that .5 mV at a level of -1 neper is permitted, i.e., 1.36 mV at zero level.

$$\text{Then } F = \frac{1.36}{\sqrt{705^2 + 76^2}} = .00192 \text{ ohms/amp Hz.}$$

This corresponds to a hysteresis resistance of $8.5 \sqrt{L}$ ohms/mA Henry at 800 p:s. However, considering that the discrepancy between calculations and measurements may be considerable, at least ± 2 db even under laboratory conditions, and remembering the very critical phase relationships associated with just those inter-

modulation products which seem to be most important, and the rough nature of the calculation, it seems reasonable to allow a factor of safety of say 2, so that the hysteresis factor to be aimed at should be about $4.25 \sqrt{L}$. As a further illustration the calculation has been repeated for the case of a carrier system employing the channel allocation of Table IV but using the same type of loading. Allowing the same factor of safety the corresponding hysteresis resistance is found to be $2.5 \sqrt{L}$.

Possibility of Reducing Intermodulation Effects

Attention has already been drawn to the extremely simple nature of the laws of near end intermodulation. One notes that all the formulae 8a–15a have the same form as long as one is dealing with a third order product. Peterson has already observed that equation (4) shows the possibility of maxima and minima of far end intermodulation when n is varied (assuming that there is phase distortion).

One may, therefore, enquire whether, by some simple manipulation, intermodulation effects may under certain circumstances be reduced or even eliminated. This seems to be the case. One notes that the problem of near end intermodulation is so similar to that of impedance irregularities, due to systematic errors of capacity or inductance, that all the technique of allocation may be immediately applied. Further, a most important result, as the summation of near end intermodulation products is concerned mostly with the phase constant at the frequency of the product considered, measures which reduce one product at a given frequency will usually reduce all products at that frequency.

Thus, to take a simple case, consider a continuously loaded cable such that the intermodulation e.m.f. per unit length for pieces of core up

TABLE IV

Channel	Frequency p : s	Description	Carrier Frequency p : s
A	300 – 2,700	Voice frequency	—
B	3,300 – 5,700	Carrier	6,000
C	6,400 – 8,800	Carrier	9,100
D	9,600 – 12,000	Carrier	12,300
E	13,000 – 15,400	Carrier	15,700

to a distance Λ from the sending end is:

$$\bar{E}_h = \frac{1}{2} m \bar{I}_a^2 e^{-(2\beta_a + j\rho\alpha_a)\Lambda},$$

λ being the distance from the sending end and that from Λ to ∞ the e.m.f. is

$$\bar{E}_h = m \bar{I}_a^2 e^{-(2\beta_a + j\rho\alpha_a)\lambda}.$$

Then the value of r is given by:

$$r = \frac{mI_a}{4Z} \int_0^\Lambda e^{-\gamma\lambda} d\lambda + \frac{mI_a}{2Z} \int_\Lambda^\infty e^{-\gamma\lambda} d\lambda,$$

where $\gamma = 2\beta_a + \beta_h + j\rho\alpha_a + j\alpha_h$,

$$\therefore r = \frac{mI_a}{4Z\gamma} (1 + e^{-\gamma\Lambda}).$$

Now γ does not differ greatly from $2j\alpha_h$, hence if $2\alpha_h\Lambda = \pi$, r will be very small and in fact could be made zero by suitable adjustment of the e.m.f.'s. Thus it is possible to secure a marked reduction of intermodulation in the neighbourhood of a certain frequency by the application of special loading, having a smaller $\frac{\mu}{a_{02}}$ but the normal inductance, for a mile or so.

To any one familiar with this type of work there would be no difficulty in extending this idea to produce a reduction over a more extended frequency range.

In a similar way it is possible to secure a reduction in the near end intermodulation of a loaded toll entrance cable by terminating it at a suitable load point. This is merely an extension of Peterson's observation to the near end case in which the maxima and minima will be sharply defined, whereas in the far end case they will not.

In the case of far end intermodulation, the tendency for the noise in successive repeater sections to add up directly attracts attention. There appear to be two practicable methods of increasing the phase distortion between channels without increasing the phase distortion within a channel. One method, due to Rendall, is to insert a set of band filters at intervals so as to separate some or all of the channels and then introduce suitably chosen delays into the various bands, finally combining the channels with another set of filters. This method has the advantage of being applicable to a single circuit. The

amount of delay required would be very small. The distorting network might not take this actual form, any alternative giving equivalent phase shift characteristics being acceptable. This method is applicable, in a modified form, to individual repeater sections, the phase adjusting networks being located at load points.

When several carrier circuits exist it is possible to adopt another expedient. Seeing that the intermodulation is worst at the lowest frequencies a decided improvement could be obtained by merely interchanging the voice channels between the various circuits by means of filters at intervals of, say, 10 repeater sections, so as to break up the parallelism between any two individual channels, and allow the phase distortion to accumulate before they are brought together again. In this way the noise will be inversely proportional to the square root of the number of circuits when the phase distortion is small.

Acknowledgments

The measurements taken upon the coil loaded line, to which reference has been made, were carried out by Mr. A. R. A. Rendall, whose general assistance and helpful suggestions in the preparation of this paper are gratefully acknowledged. The author is also indebted to Mr. C. S. Kieran for his invaluable help in measuring the intermodulation effects of the Italy-Sardinia cable.

Summary

An alternative method is given for calculating the intermodulation e.m.f. induced in a loading coil or piece of loaded conductor when traversed by a current consisting of two sine waves, and some observations are made on the relation between the various intermodulation e.m.f.'s. and the corresponding e.m.f.'s. when only a single sine wave is present.

A series of convenient formulæ is developed for general use in studying intermodulation or third harmonic effects in loaded cable. Some details are given of the intermodulation effects actually experienced on the Italy-Sardinia cable, and upon an artificial cable.

Methods of reducing intermodulation effects are explained.

Appendix

LIST OF SYMBOLS

f_1, f_2	— Upper and lower frequencies of a speech channel (Hz).	n	— Number of loading points.
f_a, f_b	— Frequencies of sinusoidal components of fundamental field or magnetising current (Hz).	Z_a	— Mid load impedance of line in ohms at frequency f_a .
f_h	— Frequency of intermodulation product (Hz).	Z_h	— Mid load impedance of line in ohms at frequency f_h .
p, q	— Angular velocities corresponding to f_a, f_b or $\frac{f_a+f_b}{2}$ (rad/sec)	\bar{I}_h	— Total R.M.S. intermodulation or harmonic current in amperes flowing at the end of the cable. In the case of a coil loaded cable, this would be the current flowing in the first or last loading coil.
ω	— Angular velocity corresponding to $\frac{f_a-f_b}{2}$ (rad/sec)	r	— Defined by equation (4).
$2a \pm b, 2b \pm a$	Abbreviations for intermodulation products of frequencies ($2f_a \pm f_b$) and ($2f_b \pm f_a$).	B_h	— Total attenuation of cable in nepers at frequency f_h .
h	— Instantaneous field (oersteds).	θ	— An arbitrary angle (radians).
H	— Envelope of the field wave (oersteds).	ml	= M which is defined by equation (2). This expression is used in the case of a continuously loaded cable.
B	— Instantaneous flux (gauss).	Z	— Impedance in ohms of a continuously loaded cable, assumed equal for f_a and f_h .
a, b, c	— With single suffix, coefficients of Fourier series.	P	— Power in watts transmitted into the line.
a	— With double suffix, coefficients of double power series.	F	— Hysteresis resistance of coil in ohms per ampere hertz.
t	— Time in seconds.	μ	= μ_{10} = permeability. (gauss/oersted.)
\bar{E}_h	— R.M.S. value of harmonic or intermodulation e.m.f. (volts).	L_X	— Added inductance in henries per unit length in the case of a continuously loaded conductor. Units as for l .
N	— Number of turns of wire on loading coil core.	L_T	— Total inductance in henries per unit length in the case of a continuously loaded conductor. Units as for l .
A	— Cross sectional area of magnetic circuit in sq. cms.	C	— Capacity in farads per unit length. Units as for l .
D	— Mean diameter of magnetic circuit in cms.	R_h	= $20 \log_{10} \frac{1}{r}$ db.
\bar{I}_a, \bar{I}_b	— R.M.S. values of fundamental current in amperes flowing through the coil or piece of loaded conductor at the sending end.	S_h	= $.115 B_h$ db.
M	— Defined by equation (2).	K	— Amplitude of each of the two equal sinusoidal components of the inducing field (oersteds). ^y
γ_a	— $\beta_a + j\alpha_a$. Propagation constant per unit length of cable at frequency f_a .	$P \ \& \ Q$	— Amplitudes of the sinusoidal components of the inducing field (oersteds).
γ_h	= $\beta_h + j\alpha_h$. Propagation constant per unit length of cable at frequency f_h .	k	= $\frac{Q}{P}$
l	— Length of loading section or of a short piece of loaded conductor. The same units to be used as for γ_a and γ_h .	κ	= $\frac{Qq}{Pp}$
		ρ	= $\frac{f_h}{f_a}$

\bar{I}_{a+b}	$= \sqrt{2} \bar{I}_a$	ψ	— Noise in noise units.
σ	— Coefficient depending on the type of intermodulation.	α	$= (\rho\alpha_a - \alpha_h) nl$.
n_r	— Number of repeater sections.	f_o	— Cut-off frequency.
Ψ_o	— Overall noise in millivolts.	R'_h	— Constant used in noise estimation.
Ψ_r	— Repeater section noise in millivolts.	Λ	— Length of cable having special characteristics.
Ψ	— Noise in millivolts.	γ	$= 2\beta_a + \beta_h + j\rho\alpha_a + j\alpha_h$.
		λ	— Distance from sending end.



TRANSMISSION LABORATORY

NORTH WOOLWICH PLANT

STANDARD TELEPHONES AND CABLES, LTD.

LONDON, ENGLAND



THE SS. NORMANDIE AND THE NEW YORK SKYLINE

THE LATEST SUPERLINER OF THE FRENCH LINE (LA COMPAGNIE GÉNÉRALE TRANS-ATLANTIQUE) PROBABLY CONTAINS THE MOST ELABORATE AND COMPLETE SET OF TELEPHONE AND SIGNALING INSTALLATIONS YET SEEN ON BOARD AN OCEAN-GOING VESSEL

The Telephone and Signaling Systems on S.S. Normandie

By S. V. C. SCRUBY

Technical Director, Le Matériel Téléphonique, Paris, France

THE French Line's latest superliner Normandie has been provided by Le Matériel Téléphonique, Paris, with what is probably the most elaborate and complete set of telephone and signaling installations yet seen on board an ocean-going liner. The equipment falls under the following four heads:

- (1) The telephone installation.
- (2) The manual fire alarm system.
- (3) The watchmen's patrol signaling system.
- (4) The service-call system.

The Telephone System

The telephone installation consists of a manual multiple switchboard for the passengers, officers, and crew, and an entirely separate "security" switchboard for the main fire station.

Until about 1930, telephone installations provided on French passenger boats were limited to small switchboards for some forty lines, for the officers' use only. No telephone service was provided for the passengers who had at their disposal simply one of the well known call systems for stewards, etc.

The French Line, La Compagnie Générale Transatlantique, after studying the private branch switchboards as used in large hotels, has consistently been in favour of placing telephone service at the disposal of their passengers, since the service rendered to transatlantic passengers is comparable from all points of view with that expected in the most palatial hotels.

Manual telephone switching for the passengers' service has been chosen in preference to automatic since, on transatlantic liners, as in the best hotels, service to clients is of paramount importance and, from this point of view, an operator's assistance is essential to provide for the varying needs of the passengers.

There are other reasons in favour of manual switching. A passenger is nearly always answered by the same operator who very soon recognizes him and his needs. Moreover, it is clear that

manual operation permits preferential treatment and "filtering" of calls, when required.

For the officers, telephone switching could readily be either automatic or manual. Manual switching has been adopted for the sake of uniformity in view of the number of manual positions already necessary for the passengers' service.

Manual switching has also been preferred for similar reasons for other "floating palaces," such as the SS. Lafayette, Atlantique, Champlain, Ile de France, etc. The comparative table on the following page gives the telephone installations aboard these liners.

Over six hundred telephones are in service throughout the Normandie, more than are to be found in many French towns of 20,000 or more inhabitants. Such figures speak for themselves and indicate the importance attached to the telephone service on an ocean liner.

Telephones are provided in all the de luxe suites, first class, and many other cabins, and throughout the different offices, agencies, and shops, quite apart from the ship's services.

Officers' telephones are provided to facilitate the transmission of all orders necessary for the administration and command of the ship.

To give an idea of the distribution of business and official telephones throughout the ship, the following list may be of interest:

Principal officers.....	7 sets
Other officers.....	5 "
Pursers.....	6 "
Doctors.....	4 "
Head waiters.....	5 "
Chefs.....	3 "
Reception clerk.....	1 "
Pantrymen.....	4 "
Wireless operators.....	3 "
Information Bureaus.....	3 "
Infirmary.....	2 "
Luggage Rooms.....	2 "
Kitchens.....	2 "
Bars.....	3 "
Lifts.....	11 "
Miscellaneous.....	14 "

The post office, wine cellar, printing office, carpenter, leader of the orchestra, etc., are provided with one set each.

The Officers' and Passengers' Telephone System
(Figs. 1 and 2)

The system comprises:

(1) A one-position official switchboard, with a capacity of 120 lines.

This switchboard is used for intercommunication amongst the officers and crew. Further, when the ship is in port, at Le Havre or New York, ship-to-city connections are provided for.

(2) A three-position switchboard with a capacity of 650 lines for passengers' service.

This switchboard is placed in the same room as the officers' switchboard and is lined up with it. It is used for all connections between one passenger and another, and between passengers and the different services and offices of the ship.

It is also used for ship-to-city calls when in port, for which purpose ten land lines are provided.

These switchboards are, in general, similar to standard manual private branch exchanges of the ordinary lamp signaling common battery type and the method of operation is also similar, except that secret service has been provided for.

The officers' and passengers' switchboards are staffed with from one to four operators, in accordance with the volume of traffic and the time of day. Switching keys are provided for concentration of operators and the use of cord circuits on adjacent positions. In slack hours, the entire traffic can be handled from one position.

(3) The following telephone sets:

- (a) Officers' telephones, including 38 table sets with dials (all dials are suitable for dialing direct into the New York or Le Havre automatic city networks), 30 wall sets with dials, and 12 wall sets without dials.

Name of Ship	Type	TOTAL CAPACITY			Remarks
		Officers' Service	Passengers' Service	Security Service	
Lafayette.....	L.M.T. Manual	1 switchboard with capacity 40 lines.	1 2-position switchboard with capacity 400 lines (320 equipped).		7 direct lines between officers' sets and the bridge.
Atlantique.....	L.M.T. Manual	1 switchboard with capacity 80 lines, 6 city trunks and 3 auxiliary lines (for city connections to passengers' cabins when ship is in port).	1 2-position switchboard with capacity 300 lines (fully equipped).		
Champlain.....	L.M.T. Manual	1 switchboard with capacity 60 lines, 6 city trunks and 10 auxiliary lines (for city connections to passengers' cabins when ship is in port.)	1 2-position switchboard with capacity 400 lines (350 equipped).		
Ile de France.....	L.M.T. Manual		1 2-position switchboard with capacity 400 lines (fully equipped).		
Normandie.....	L.M.T. Manual	1 switchboard with capacity 120 lines (80 equipped), 10 city trunks, 10 trunks to security switchboard and 10 cords.	1 3-position switchboard with capacity 650 lines (562 equipped), 10 trunks to security switchboard, 10 city trunks, 30 cords.	1 switchboard with capacity 120 lines (90 equipped), 10 trunks to officers' and passengers' switchboards, 6 cords.	

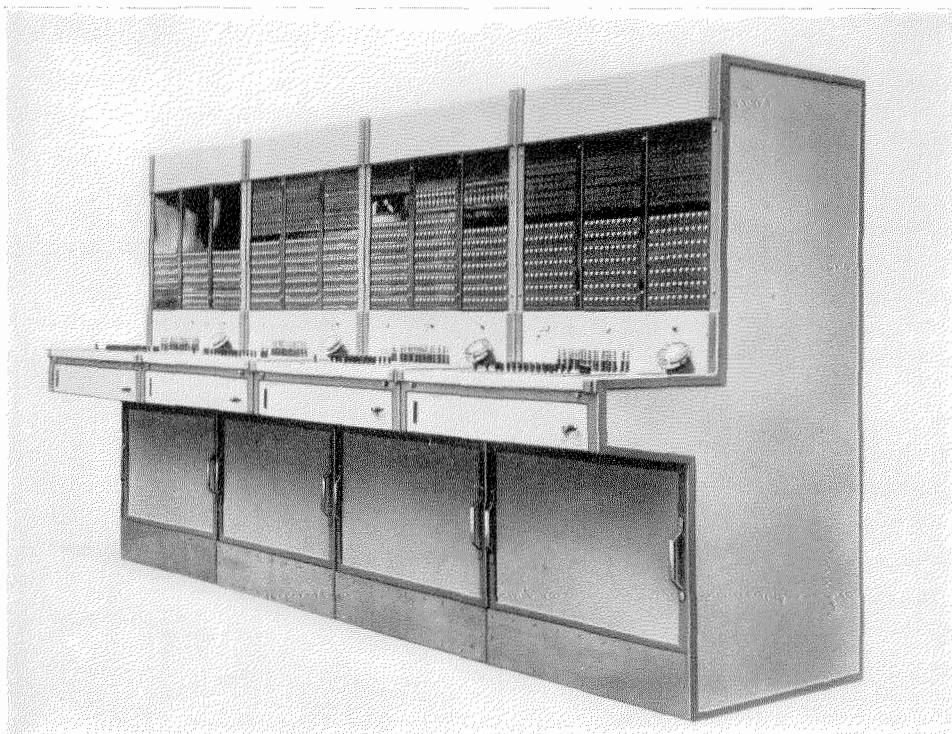

Figure 1—Officers' and Passengers' Telephone Switchboards—Front View.

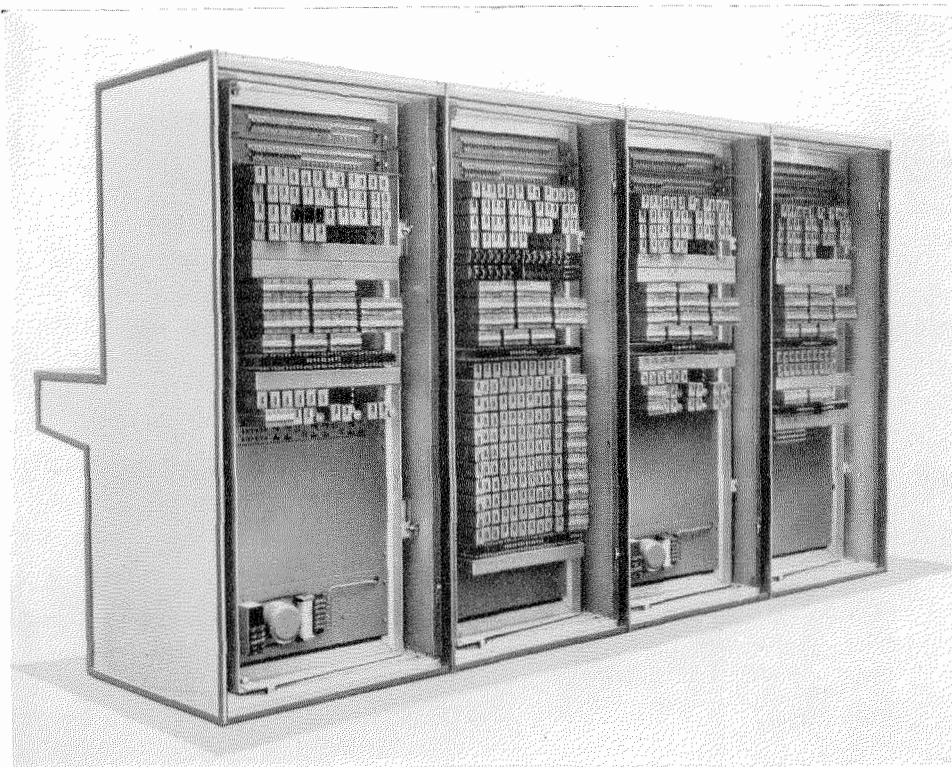

Figure 2—Officers' and Passengers' Telephone Switchboards—Rear View—Doors Removed.

- (b) Passengers' telephones, including 54 wall sets, and 492 table sets, 14 being for grand luxe suites, and 8 for de luxe suites.

The passengers' telephones have no dials since, when in port, city connections are obtainable via the operator.

- (c) 16 telephone sets for direct point-to-point service.

(4) Special service switchboards for the order offices of the central pantry for first class passengers.

There are two of these 5-line switchboards enabling connections to be established to and from the passengers' and officers' switchboards.

(5) A main distributing frame and junction boxes.

The main frame is wall-mounted, of metal construction, and is entirely enclosed. It is installed in the same room as the officers' and passengers' switchboards.

Arrangement of the Officers' Switchboard

This switchboard is lined up with those assigned to passengers' service and is an all-metal position equipped as follows:

- 120 officers' lines
- 10 city trunks
- 10 tie-lines to the Security switchboard
- 10 pairs of cords arranged for through dialing
- 1 operator's circuit
- 1 ringing circuit
- 1 pilot lamp circuit
- 1 fuse alarm circuit
- 1 spare magneto
- 1 alarm-type fuse panel, etc.

The number of lines actually connected is eighty, which can be increased as desired.

Arrangement of the Passengers' Switchboard

This switchboard comprises three all-metal positions, equipped as follows:

- Position 1*—210 extension line jacks
 210 multiple jacks
 10 pairs of cords
 1 operator's circuit
 1 ringing circuit
 1 pilot lamp circuit
 1 fuse alarm circuit
 1 spare magneto
 1 alarm-type fuse panel, etc.
- Position 2*—230 extension line jacks
 10 multiple jacks of city trunks
 10 tie-line multiple jacks
 10 pairs of cords
 1 operator's circuit and common circuits as above
- Position 3*—The same equipment as for Position 1

On these positions, the cabin numbers and the names of the different public rooms, offices, etc., are indicated.

Arrangement of the Special Service Switchboards

These are all-metal cordless switchboards, each comprising:

- 5 extension lines
- 5 lines to the passengers' and officers' switchboards
- 1 operator's telephone circuit

They are used for connections to and from the different telephone sets installed in the pantry. The operator can receive calls from any of these sets, connect any two sets together, or connect any set to a line leading to the passengers' switchboard for registering customers' orders. These switchboards are only staffed during busy hours since, during normal periods, all such orders are handled directly by the regular operators at the passengers' switchboard, to which the sets are directly switched.

Arrangement of the Main Distributing Frame

The frame is equipped for:

- 120 officers' lines
- 650 passengers' lines
- 10 city trunks
- 10 junctions to the security switchboards
- 10 battery feed lines to point-to-point sets and the special service switchboards
- 180 spare lines

Construction of the Switchboards

The four-position switchboard is of special construction and manufactured entirely of steel. The different positions are separated from one another by sheet metal. All the metal work is finished with fireproof enamel and all exposed surfaces with vitrified enamel.

Special Features

Certain special features have been introduced as follows:

Secret Service

Secret service is provided both for local and city connections. With an ordinary manual P.B.X., the operator can listen-in on any connection, either by operating the listening key of the cord pair used for establishing the connection, or by using two plugs of different cord pairs for establishing a connection and depressing both listening keys simultaneously. On the SS. Nor-

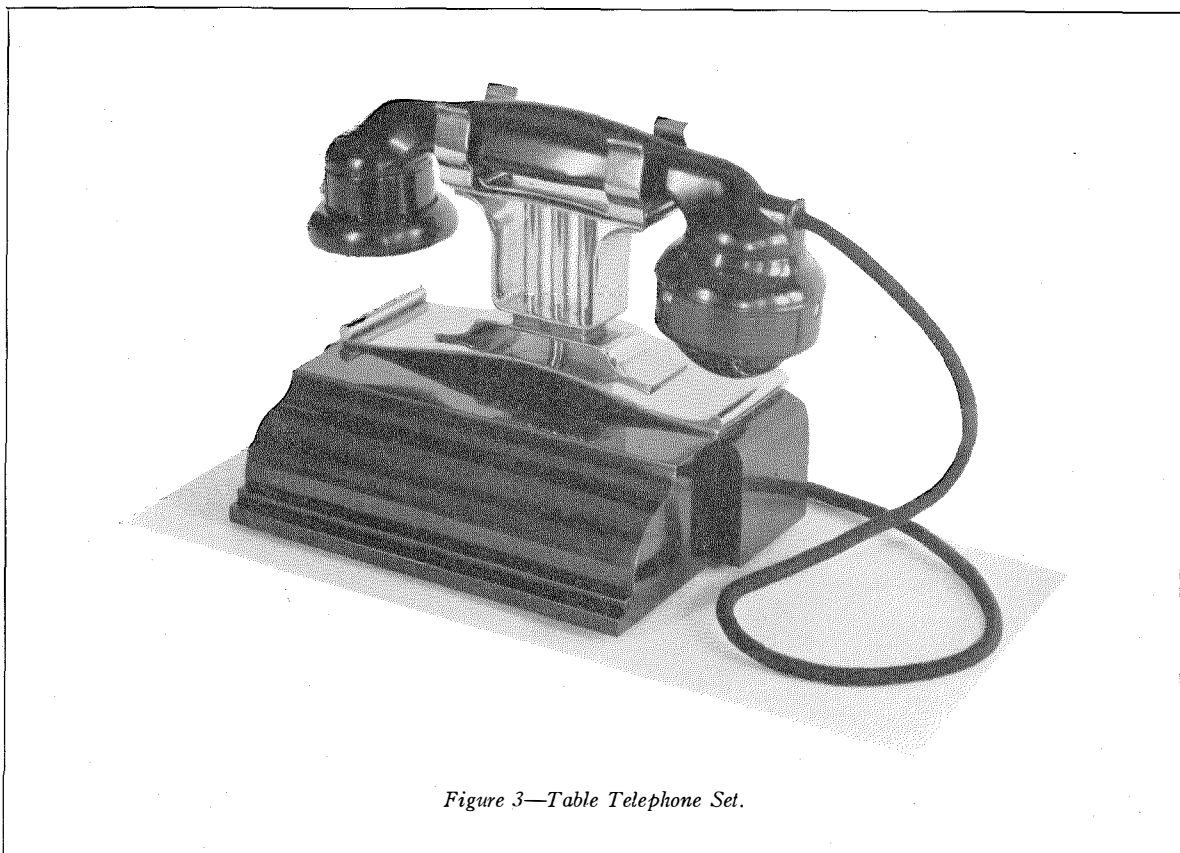

Figure 3—Table Telephone Set.

mandie, overhearing by these or any other methods is electrically prevented.

Should the operator depress the listening key during a local connection, a relay is operated if the called party has answered, thereby disconnecting the operator's telephone circuit. On a city connection, when the listening key is depressed, the talking circuit between the local party and the city party is disconnected and the operator may speak only with the local party; in order to converse with the city party, it is necessary to depress a special key, which disconnects the local party. The operator thus has the means of conversing with either local or city party but not with both simultaneously.

Should the operator attempt to establish a connection by using cords of a different pair and depressing both listening keys, a differential relay operates and, through other relays, disconnects the operator's telephone circuit.

Connections with the City Networks when in Port

Circuits are provided for connections between

the ship and the city telephone system, when in port, either in New York or Le Havre.

For automatic city systems, the operator is provided with a dial. The junctions are of the impulse-repeating type, so that the dial impulses are not sent directly into the automatic city system but are relayed by the relay repeater. As already explained, secret service is provided on these calls.

Connections with the Security Switchboard

Interworking junctions are provided between the passengers' and officers' switchboards for all regular connections and also for connections to and from the security switchboard. Only local connections are possible over these tie lines; connections with the city network, when in port, being electrically prevented.

The Telephone Sets

All sets are of metal or of bakelite construction and are designed for use at sea and in tropical climates; their finish is such as to harmonise with the surroundings. The hand microtele-

phones are of the so-called "French" type, and the sets are fitted with soft rubber pads on the switchhooks, as well as rubber feet to act as antirolling devices.

The table set (Fig. 3) is of particular interest as its design is a departure from usual telephone practice. As regards outward appearance, it was designed by an artist along modern lines and is in keeping with the general decorative scheme of the ship.

All sets, except those for point-to-point connections, have bells mounted within. For protection purposes, all sets are fitted with fuses within the set.

Circuit Features

Figs. 4-a to 4-f, inclusive, show the circuits used on the officers' and passengers' switchboards. The following comprise the principal features not previously mentioned:

- (1) The cord circuits are universal and may be used for all kinds of calls.
- (2) It is impossible to interchange the plugs of a cord pair connecting a city line to an extension line.
- (3) High efficiency transmission bridge on city connections. The local extension is fed from the P.B.X. battery.
- (4) Unrestricted city service for local extensions. No city service over tie lines.
- (5) Double supervision on local calls.
- (6) The city exchange cannot be rung by mistake.
- (7) Outgoing city calls can be established either by the operator or by direct calling from extensions.

In the former case, as on incoming calls, the regular supervisory signal is given to the operator when the extension hangs up, so that he can recall by "flashing." The city trunk is released when the operator unplugs. In the latter case, a special dialing key associated with

the cord, is depressed and provides for direct dialing from the extension set, release of the city connections under switchhook control and, consequently, several successive connections without the operator's assistance. Splitting of the trunk circuit occurs automatically when the telephone is hung up and if an incoming call arrives before the plugs are removed, the line lamp burns but the extension is not again rung.

The system is designed for operation on 24 volt supply.

Detailed Circuit Operation—Local Calls

The calling party lifts the handset of his telephone and so closes a loop on the line, causing the line lamp AL and the pilot lamp APL to light (Figs. 4-a and 4-b). The operator inserts the rear plug FR of a free cord (Fig. 4-c) in the calling line jack, thus disconnecting the line lamp and grounding the sleeve. The line is thus made busy throughout the board. Ground on the sleeve of the jack operates relay Sr and closes the talking circuit. The battery feeding circuit of the calling set is from battery—winding of Rar—front contact of Sr—key NDC—winding of Rsr (shunted by 2 MF.)—key ARC—plug and jack—substation loop—jack and plug—keys ARC and NDC—front of Sr—winding of Rar to ground.

The supervisory relay Rsr operates and prevents the supervisory lamp SRL from lighting. The operator depresses the speaking key EC. Relay Sar operates over the loop in the operator's set and extinguishes supervisory lamp SAL on the calling side of the cord. The circuit for relay Sar is from battery—winding of Sar—key AAC—back of ER—key EC—key EEC (Fig. 4-d)—back of Sr—winding of BS₂—impulsing contact

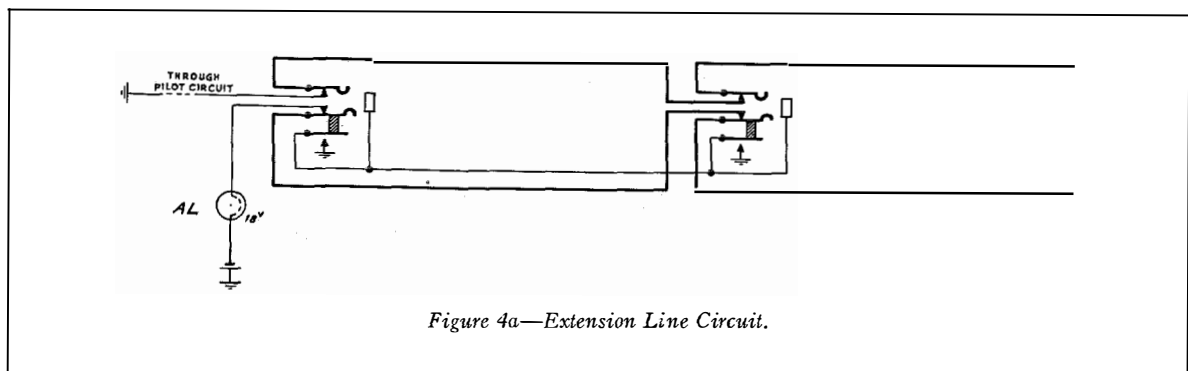
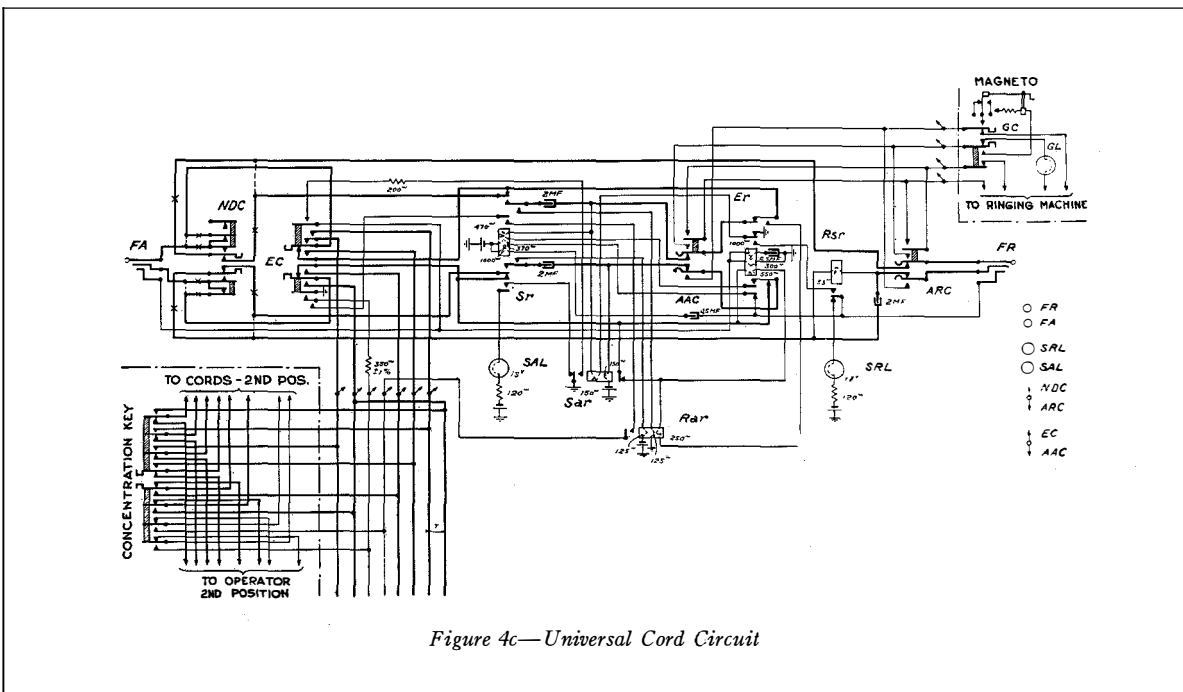
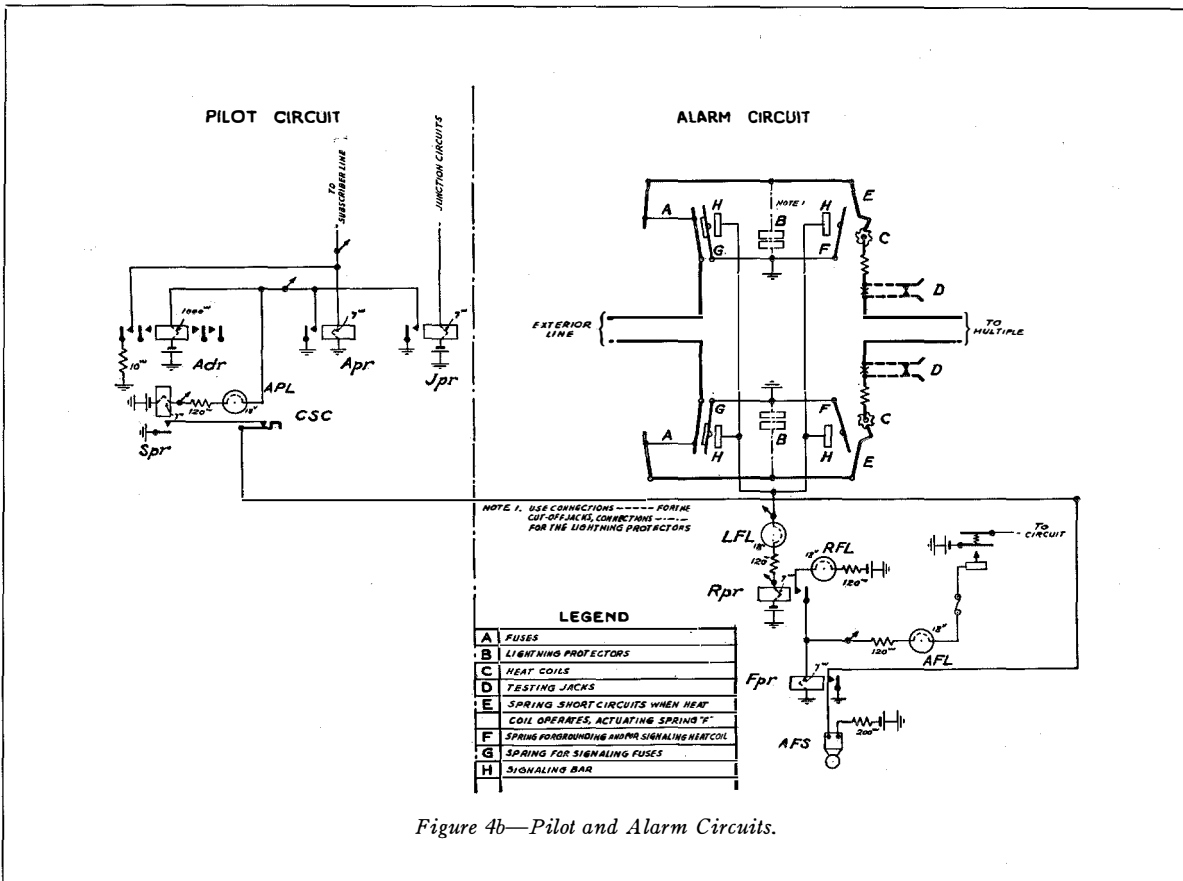

Figure 4a—Extension Line Circuit.



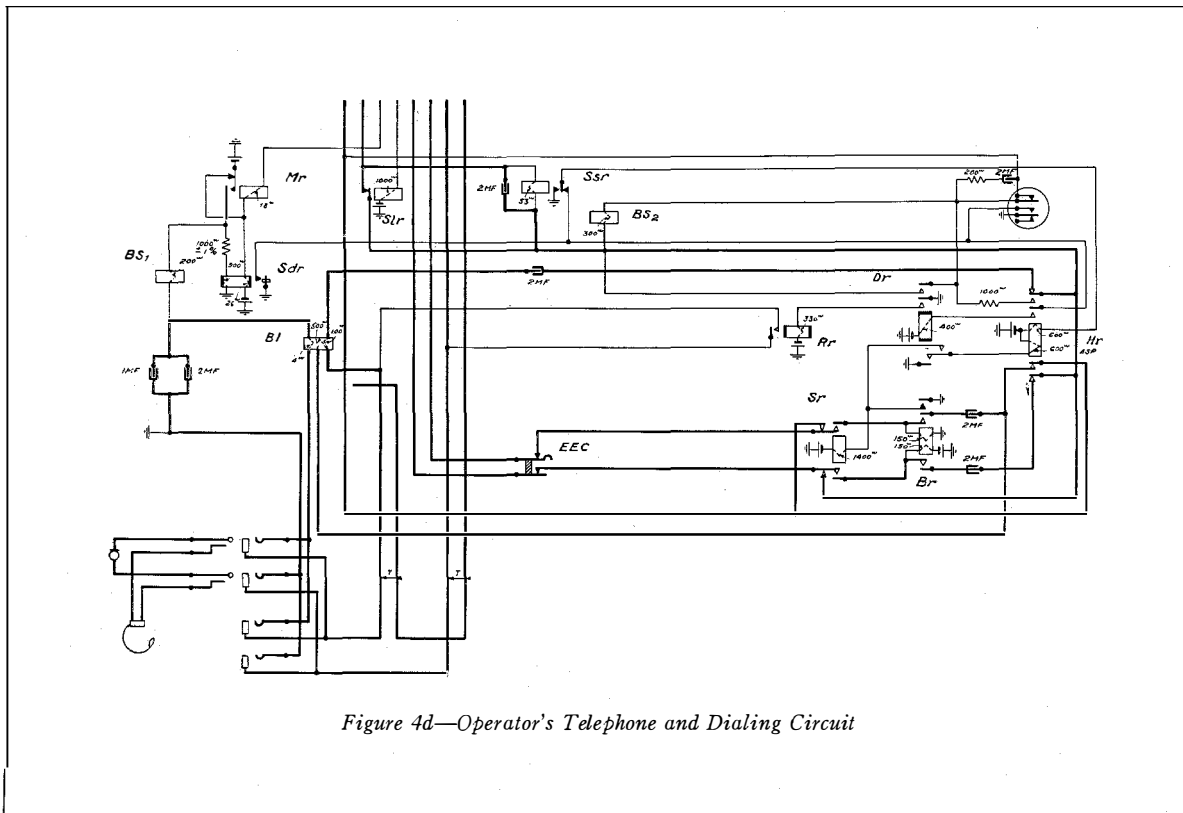

Figure 4d—Operator's Telephone and Dialing Circuit

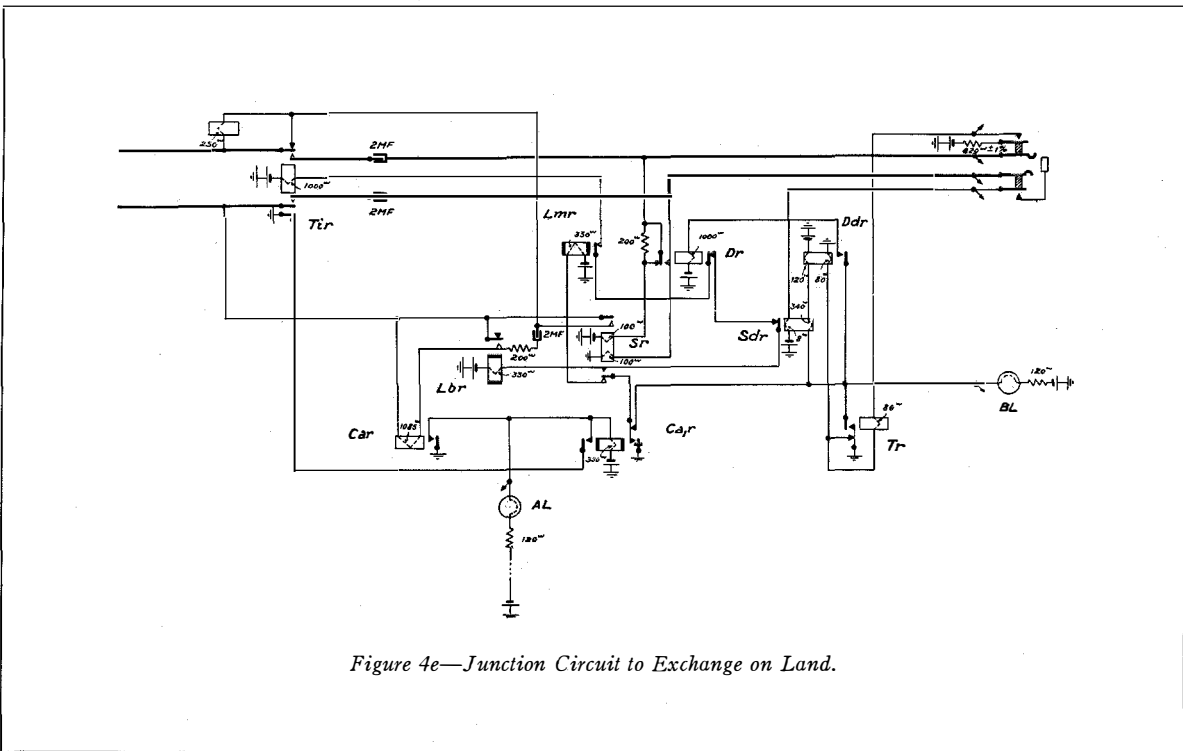

Figure 4e—Junction Circuit to Exchange on Land.

of dial—back of Sr—key EEC—key EC—back of Er—key AAC—winding of Sar—back of Er to ground.

The operator talks to the calling party through the battery feeding bridge condensers. Assuming that a local line is called, the operator keeps the speaking key depressed and tests the line by touching the jack sleeve with the tip of the front plug FA. If the line is busy, the sleeve of the jack is grounded. One winding of Sar is short-circuited and the resulting discharge in the winding of the induction coil gives the operator the characteristic busy click. If the line is free the operator inserts the plug and restores the speaking key. Relay Sar releases, and supervisory lamp SAL lights. The operator depresses the ringing key AAC. When the called party removes the handset, the supervisory relay Sar operates and extinguishes lamp SAL. The conversation then takes place.

When each party hangs up, the corresponding supervisory lamp lights. The operator then removes the plugs. At any moment during the connection, the operator has the supervision of the calling party and can ring back by means of ringing key ARC.

Battery Supply to the Operator's Telephone

Whenever the speaking key EC of a cord is depressed, relay Mr (Fig. 4-d) operates in series with the resistance.

Mr connects battery through the retardation coil BS₁ and the primary winding of the induction coil BI to the microphone. At the same time, the left-hand winding of relay Sdr is closed in series with the resistance and the short circuit around the other winding is opened. Relay Sdr is differentially wound and cannot energise under these conditions.

Secrecy on Local Calls

If the operator attempts to listen in on an established connection by depressing the speaking key, his set is disconnected as a result of the following operations:

Relay Slr in the operator's circuit energises from battery—winding of Slr—front of Rsr—front of Sr—key EC to ground. Relay Slr opens the short circuit around relay Sar which is thus connected in series with the called line loop and operates. Ssr causes relay Hr to operate and disconnect the operator's set.

If the operator attempts to listen in by estab-

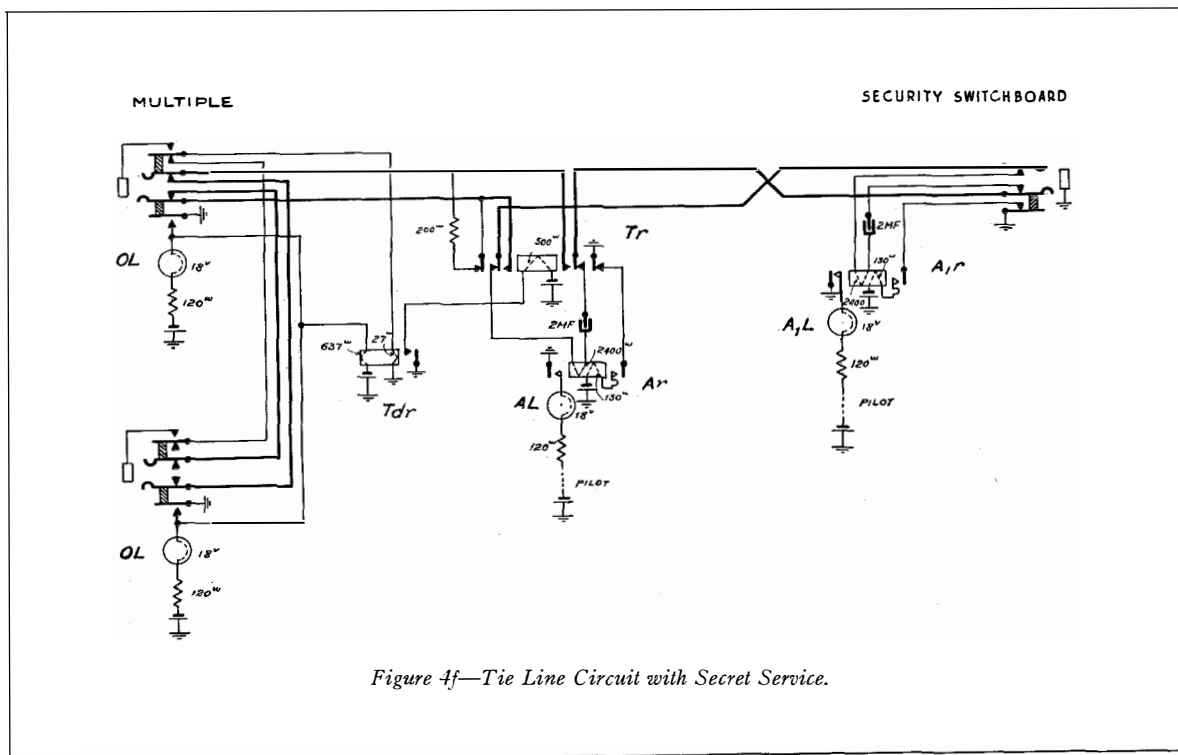

Figure 4f—Tie Line Circuit with Secret Service.

lishing a connection with two separate cords and both speaking keys depressed, his set is similarly disconnected as follows:

As already explained, differential relay Sdr does not operate when a single speaking key is depressed. Whenever the operator depresses a second speaking key, the current in the right-hand winding of Sdr is increased, the relay is unbalanced and operates, causing the operation of relays Hr, Ddr, and Rr. Relay Hr cuts off the operator's set and Rr short-circuits his receiver.

Outgoing Calls to a Manual City Exchange

For an outgoing city call, the operator inserts a front plug in the jack of an idle city line (he may leave the rear plug in the local jack or withdraw it and recall afterwards). In the cord circuit (Fig. 4-c), relay Er operates to the battery on the sleeve of the city line jack in series with the right-hand winding of Sdr (Fig. 4-e). Relay Er opens the circuit of Sr which releases and cuts off the feeding bridges of the cord circuit. The local line is thus directly connected to the jack circuit of the city line from which battery feed is provided via Sr. The supervisory relay Rsr remains connected in the "b" wire in the cord circuit, and the talking wires are bridged by an impedance in the circuit from the "a" wire—front of Er—right-hand winding of Rar—lower non-inductive winding of Er—to the "b" wire.

Er also places Sar under the control of Rsr in a circuit from ground on sleeve of plug FR—front of Rsr—front of Er—winding Sar—non-inductive winding Sr—front Er—key AAC—winding of Sar to battery.

The lower winding of Er is normally short-circuited by a back contact of Sar so that when the handset of the local line is removed, Sar is operated and the bridging loop is increased in resistance. The battery feed to the handset is thus not unduly reduced by the shunt. When, on the other hand, the handset is replaced, Sar releases and the cord circuit loop is reduced to the resistance of relay Rar. The operator has, at any moment, full supervision of the local subscriber, the lamp SRL being directly controlled by Rsr, as before.

In the city trunk circuit, when a plug is inserted, relay Tr energises and causes the busy lamp BL to light. The right-hand winding of

relay Ddr is connected in series with relay Tr and a resistance to battery. The left-hand winding of Ddr is connected in series with the right-hand winding of Sdr. The left-hand winding of Sdr is in series with Er in the cord circuit. Under these conditions, the two differential relays Ddr and Sdr remain unoperated. Relay Sr operates on the loop in the cord circuit or at the substation. Sr loops the line to the city exchange and a call is thus originated in this exchange. Relay Tir operates and extends the line to the jack and cord circuit through condensers.

The operator depresses the speaking key EC, asks for the called party and then rerings the calling party, if necessary, and restores the speaking key. When the local subscriber answers, the connection is established.

Outgoing Calls to an Automatic City Exchange

The operator originates the call as described above, waits for the dialing tone and then dials the wanted number. As soon as the dial is moved off-normal, the following operations take place in the operator's telephone circuit (Fig. 4-d):

Relay Hr operates, disconnects the operator from the line, and closes a circuit for Dr which operates. Dr short-circuits the coil BS₂. At the same time, Rr operates and short-circuits the operator's receiver. Dr closes a locking circuit for Hr. The dial impulses are repeated over the trunk circuit as shown later. When the dial has returned to its normal position, Dr releases and opens the short circuit around BS₂, which is shunted by a resistance over the front contact of Nr, while the relay is released, in order to minimise the effect of introducing the additional inductance. Relay Rr releases slowly and removes the short circuit around the operator's receiver only after the condenser discharges have taken place.

The dial impulses are received and repeated to the city trunk by relay Sr. When Sr closes its back contact at the beginning of the first impulse, the slow releasing relay Lmr operates and remains operated during the train of impulses. It releases Tir which closes the loop directly on the front contact of Sr. The slow releasing relay Lbr also remains operated during the train of impulses. A condenser and a resistance are connected as a spark-quencher over the front con-

tact of Sr. At the end of each train of impulses, Lmr releases, closing again the circuit of Tir which reoperates and reestablishes the speech circuit.

When the local subscriber remains on the line during the establishment of a city call by the operator, the latter is disconnected from the exchange line as described above. In order to listen for dialing tone or to talk over the city line, the operator momentarily depresses the positional key EEC. This disconnects the calling side of the cord, causing supervisory relay Rsr to release, followed by Sar.

In the trunk line, relay Sdr releases and allows Tir to reenergise and extend the city trunk to the cord and operator's telephone. During dialing, Sr in the operator's telephone circuit is operated by Dr and provides a special feeding bridge for the local substation over Br, which operates on the loop and maintains Sr in the operated position. At the end of dialing, the operator depresses momentarily key EEC in order to listen for ringing or busy tone, as before. Br and Sr then release. To complete the connection, the operator restores the speaking key and rerings the calling party, if necessary.

Should it be necessary, for any reason, for the ship's operator to speak over the city trunk while his local party is on the line, a special positional change-over key EEC is provided for use in conjunction with the regular speaking key. This feature is necessary to maintain the secrecy requirements. Thus, on any city connection with the calling party on the line, should the ship's operator depress the speaking key, he is connected to his local party only, whereas, with the positional change-over key operated as well, the ship's operator is connected to the city trunk and the local party is disconnected.

Direct Dialing from Substation to City Exchange

On outgoing automatic city calls the operator may operate the "direct dialing" key NDC of the cord circuit. The subscriber's line is then directly connected to the trunk circuit. The subscriber himself dials, and controls the connection, or several successive connections, without further intervention on the part of the operator. Local supervision, however, is given by the operator in the same manner as for ordinary calls established by him.

If the city line is seized for an incoming call before the ship's operator has withdrawn the plug used for a previous connection, Car and Ca_{1r} operate in the trunk circuit and cause the line lamp to light. Ca_{1r} operates Lmr so that, in the event of the local substation calling again, Tir does not reoperate and the station is not again connected to the trunk.

Incoming City Calls

The ringing current sent by the city exchange is received in the trunk circuit (Fig. 4-e) and operates Car which closes a circuit for Ca_{1r}. The latter locks to the back of Tir and the calling lamp AL lights. When the operator inserts a plug, relay Tr operates and lights the busy lamp BL. Relay Sr operates over the loop in the cord or in the operator's telephone circuit and closes a circuit for Tir. Tir extends the line to the jack, and opens the locking circuit of relay Ca_{1r}, which releases and extinguishes lamp AL. Sr also closes a loop to the city line and trips the ringing circuit.

To complete the connection, the operator tests the local line jack with the rear plug of the cord; when the called party answers, the operator depresses the speaking key and becomes connected to him alone. The connection is completed by restoring the speaking key.

Secrecy on City Calls

If, during the conversation, the operator depresses the speaking key, he breaks the connection and is placed in communication with the local party alone. This results from the operation of Sdr in the city trunk circuit, this relay being unbalanced by the connection of a resistance and ground to the sleeve wire of the cord circuit by key EC. Sdr causes Tir to release and disconnect the jack circuit from the city exchange line, the latter, however, being held by the loop over the front contact of Sr, which in turn is held by a loop in the operator's telephone circuit.

If the operator attempts to listen by inserting another plug in the city line multiple, relay Ddr is unbalanced by the second resistance connected by the auxiliary contact of the jack. Ddr operates Dr which short-circuits the line and causes Tir to release.

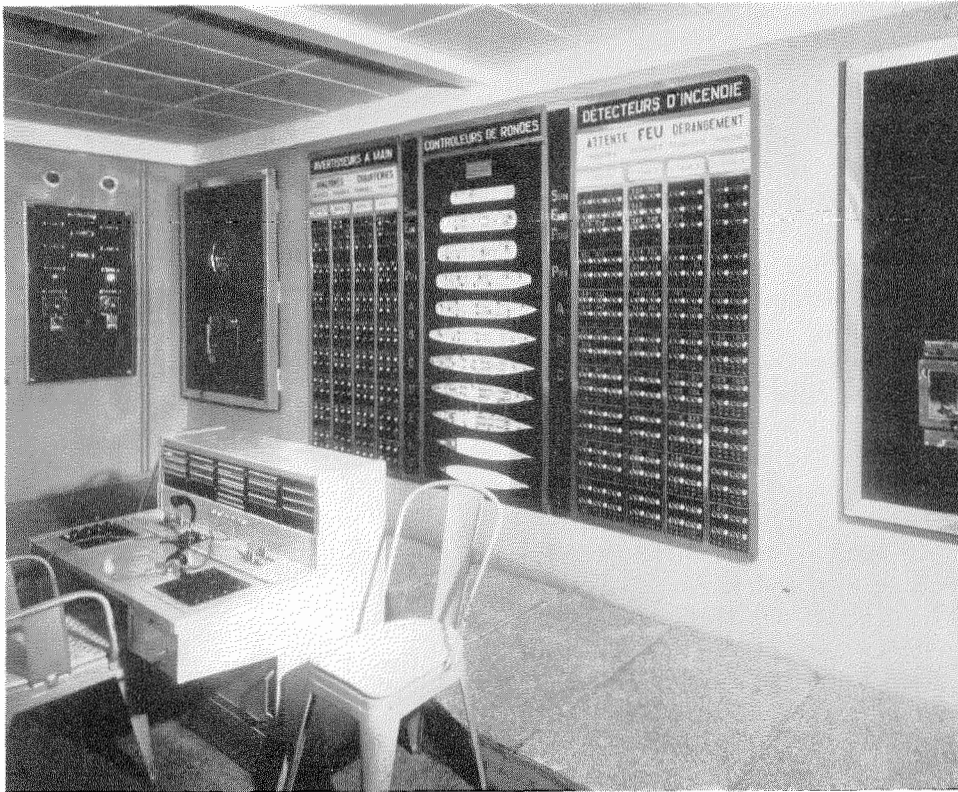

Figure 5—Main Fire Station (Republished by permission of Messrs. Desboutin, Paris).

Tie Lines with Restricted Service

Tie lines are provided only for local service between the officers' and passengers' switchboard and the security switchboard. These lines (Fig. 4-f) are operated on a ring-down basis in both directions. Busy lamps are associated with the multiple jacks in the former switchboard. Should a city connection be attempted over such a line, a circuit is closed for the differential relay Tdr in the tie line circuit from ground—winding of Tdr—jack, sleeve and plug—front of Rsr—front of Er—winding of Sar—upper non-inductive winding of Sr—front of Er—key AAC—winding of Sar—to battery.

Under these conditions, Tdr and consequently Tr cannot energise. Thus such irregular connections cannot be established.

Power Plant for Passengers' and Officers' Telephone System

This installation comprises two batteries, each

of 19 cadmium-nickel type cells with a capacity of 72 ampere-hours. The batteries are charged from the ship's 220-volt continuous current supply through adjustable rheostats. The duplicate batteries are operated on the well known charge and discharge routine.

The power board is fitted with the usual voltmeters and ammeters, and is entirely enclosed in a metal housing with a transparent window permitting easy reading of all instruments.

The Security Telephone System

In addition to the telephone system for the officers and passengers described above, there is an entirely separate security switchboard and network of lines. The switchboard is a one-position board of conventional common battery type located in the main fire station (Fig. 5). It has a capacity of 120 lines and is equipped with 6 pairs of cords with double lamp supervision. It has 10 tie lines to the officers' and passengers' switchboards, arranged to frustrate electrically

any attempt to obtain a city connection from the security switchboard. The 90 equipped extension lines terminate in sets, many of which are located inside the cupboards containing fire-fighting appliances. When this is the case, the set has no bell, but a lamp controlled over two extra wires from the line jack on the switchboard is placed in a visible position nearby.

The Manual Fire Alarm Signaling System

The manual fire alarm system, together with the "security" telephone system, provides an effective means of giving an alarm. The fire alarm system is instantly available to any person on board, whether passenger, officer, or member of the crew. It consists of a number of alarm boxes which are directly connected to the main fire station. Each box is numbered and when the glass is broken and a push button depressed, a corresponding luminous signal is displayed at the main fire station upon a board showing diagrammatically the different decks in such a way that the location of the alarm is immediately clear to the security officer on duty. Another repeat display board is provided on E deck near the main power distribution board.

The Alarm Boxes

These are watertight boxes, painted red, and fixed to different partitions. Each box is fitted with two glass windows. To give an alarm, the larger window, on which suitable instructions are painted, must be broken with the hammer provided for the purpose and attached to the box by a chain. Behind this window is the alarm button which must be depressed. The smaller window is red and is normally lighted by a lamp which is doubled by a repeat lamp at the main fire station.

These alarm boxes can be opened with a special key, for maintenance purposes.

Alarm Box Numbering

The ship is divided for fire-fighting purposes into four main divisions from bow to stern (Fig. 6). Each main division includes a portion of each deck, and each of these portions is further divided into a number of subdivisions. In each subdivision, one or more alarm boxes are installed, numbered consecutively and connected

in parallel. Each box is, in addition, numbered with a 3-digit number indicating the subdivision to which it belongs. The first digit indicates the main division, the second the deck number, and the third the subdivision of that portion of the deck. In this way, the location of a box from which an alarm has been given is immediately recognizable from its number alone. Alarm boxes located in the engine and boiler rooms are treated separately.

The Alarm Display Board at the Main Fire Station

This consists of a metal framework lined up with the boards for the watchmen's patrols and the automatic fire detectors (Fig. 5). The face equipment consists of a metal panel divided into four vertical sections corresponding to the four main divisions of the ship and carrying a lamp with a red cap and a push button key for each subdivision. These lamps and keys are numbered in accordance with the alarm boxes to which they correspond, and are arranged in groups horizontally by decks. All these lamps normally burn steadily. At the top is a glass panel on which the words "engine room," "boiler room," "division No. 1," etc., can be illuminated from behind in the event of an alarm.

The appearance of the display board and of those adjacent to it has been specially considered so as to be in harmony with the decoration of the ship. The constituent apparatus is readily accessible for test and maintenance purposes. The board has a capacity of 150 lamps and keys, and is at present equipped with 132.

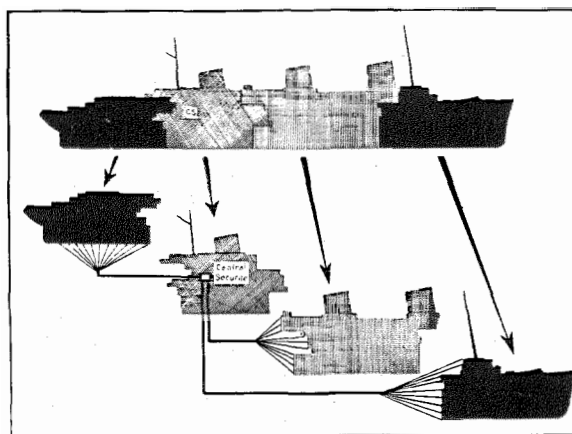

Figure 6—The Four Fire Divisions.

Repeat Display Board on E Deck

This consists of a panel with six sections with lettering corresponding to the four main divisions, the engine room, and the boiler room. A section is illuminated in the event of an alarm, whereupon the mechanic in charge of the board cuts off the ventilation in the corresponding division. This action is signaled at the main display board by the darkening of the lamp behind the inscription "ventilation No. 1," etc.

Apparatus

The circuit relays are enclosed in a metal cabinet which is also a distributing frame for internal and external connections. Each line is protected by a fuse and heat coil. The alarm bells are of watertight construction and are finished to withstand sea air.

Operation

In case of fire, the gangway watchman or anyone present gives the alarm by breaking the glass of the nearest alarm box and depressing the alarm button. The signal lamp of the alarm box is extinguished and the corresponding lamp at the display board at the main fire station flickers, and the division indicator is illuminated. All the

alarm bells operate and the main division number lights up at the repeat display board on E deck.

At the main fire station, when the alarm is received, the attendant depresses the button at the display board which relights the lamp at the alarm box, indicating that the alarm signal has been received, and the lamp at the display board burns steadily again.

Each subdivision, with one or several lamp boxes in parallel, has at the main fire station a line relay Lr, a relay Fr, and a restore key RC (Fig 7).

When the alarm button at the alarm box is depressed, a 1500 ohm resistance is short-circuited, Fr operates in series with Lr, and the two lock in series over the front contact of Fr and key RC. Lamp AL₁ at the alarm box is extinguished. The main alarm bell SGA operates and lamp FL at the display board flickers. Relay Rr operates the alarm bell pilot relay Sr₁ which locks over its front contact and in turn operates relays Sr₂ and Sr₃ which operate the other alarm bells.

For each main division, there are division relays Tr₁, Tr₂, etc., which light the main division lamps TL₁, TL₂, etc. They also operate the

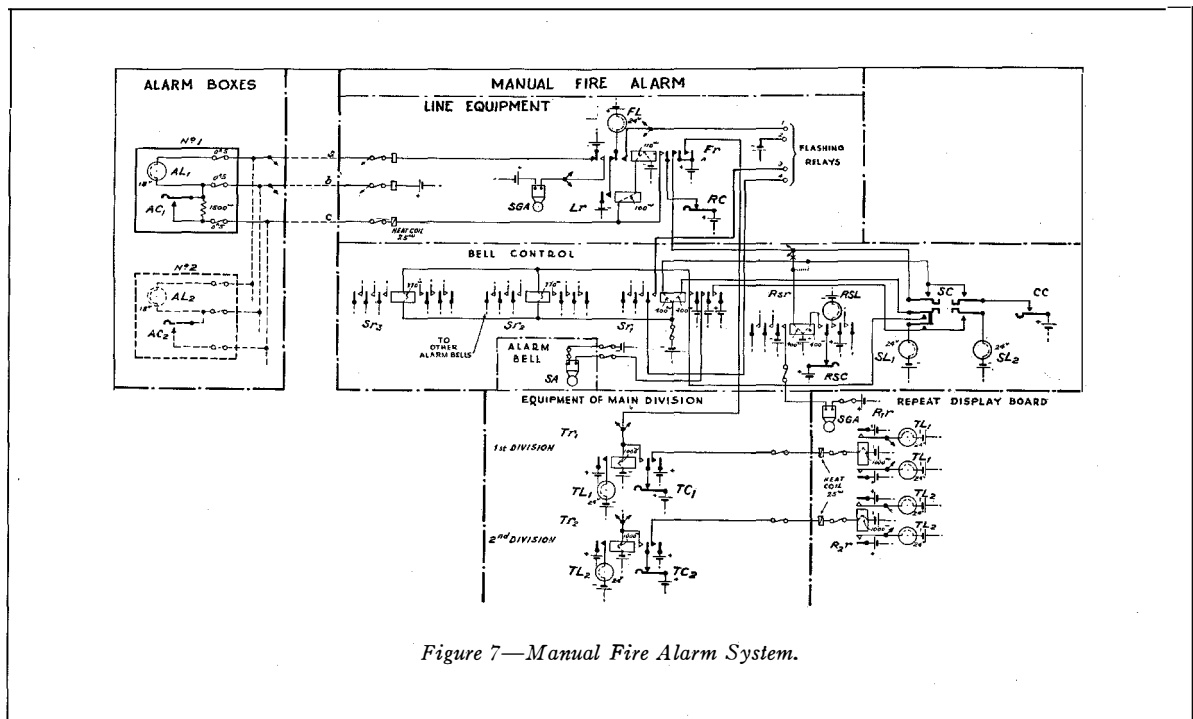

Figure 7—Manual Fire Alarm System.

division relays R_{1r} , R_{2r} , etc., at the repeat display board on E deck, lighting the division lamps, TL_1 , TL_2 , etc.

To reset the alarm circuit, key RC is depressed. The alarm bells are stopped by operating keys SC and RSC. The division lamps are restored by depressing individual keys TC.

There are in all 228 manual alarm boxes, 224 in service and 4 spares; and 16 alarm bells, 14 in service and 2 spares.

Self-Testing in Line Wires

In order to ensure the availability at all times of every fire alarm box the three line wires leading to each box are normally under current. As already stated, the lamp at the box is normally alight, and its extinction, except when an alarm is made, indicates either a blown fuse or a failure in the wiring. Similarly, relay L_r is normally operated over the third line wire in series with the 1500 ohm resistance at the box, and L_r in turn keeps the line lamp FL alight at the alarm display board.

The Watchmen's Patrol Signaling System

A watchman's patrol service is not in any way peculiar to ships but is currently used in large stores, factories, and public buildings; in fact, anywhere where hazards such as fire, water, etc., may cause considerable damage, particularly during unattended periods, if not detected in due time. The watchman patrols a predetermined round and usually operates a clock-controlled registering device at each control point to prove that the round has been properly effected at the appointed time.

On the SS. Normandie, the watchmen signal their progress, during their rounds, to a display switchboard located at the main fire station and permanently in charge of a responsible "Security Officer." This officer can thus see at a glance where all his watchmen are at any time, throughout all the decks of the entire ship.

Progress Display Board

This consists of a framework entirely of metal construction and lined up with the display boards for the automatic fire detectors and the manual fire alarms (Fig. 5).

The face equipment comprises a black metal

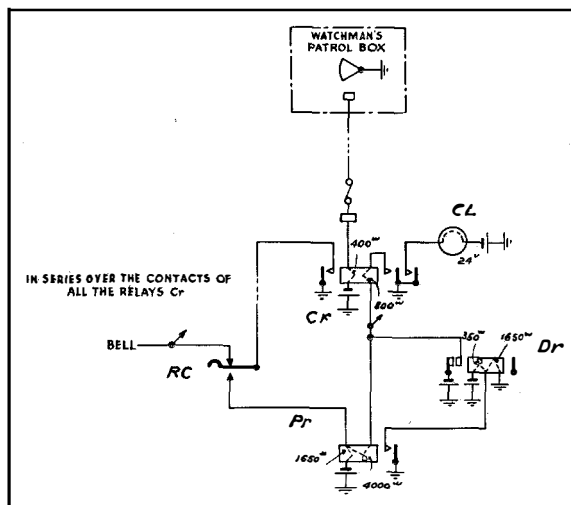

Figure 8—Watchmen's Patrol Signaling System.

sheet pierced with eleven holes, corresponding to the eleven decks, and behind these holes, protected by glass, are coloured plans of these decks. At the places on these drawings corresponding to the watchmen's control points are numbered discs which are illuminated from behind as the watchmen proceed on their rounds.

For the purpose of these patrols, the ship is divided into eight security sections or "rounds." These correspond to the four main fire divisions, there being in each such division an upper and lower "round." These eight sections are reproduced in different colours in the plans on the panel.

Watchmen's Control Boxes

These boxes provide means whereby a watchman can signal his location by inserting a key, which lights the corresponding numbered lamp on the display board at the main fire station. There are 88 such control boxes installed, 84 in service and 4 spares. They are watertight and painted the usual "signal" red. Many of them are located in the cupboards containing fire-fighting appliances.

Operation of the Circuit (Fig. 8).

When the watchman inserts his key in a particular box on his round, it operates relay C_r which locks over its holding winding (relay D_r being constantly operated under normal conditions), and lamp CL lights at the main fire

station. When the round is completed, all the CL lamps belonging to that round are lit and a control bell rings at the station.

The security officer restores the circuit to normal by depressing the restore key RC. Pr operates and short-circuits Dr which releases. The holding winding of the Cr relays is now connected in series with a high resistance winding of relay Pr, but relays Cr nevertheless release. Pr remains operated until all relays Cr have released. At this moment, Pr releases and Dr operates again; should any line wire become grounded, the corresponding Cr relay cannot release and its lamp CL remains alight, thus signaling a fault on the line wires.

Immunity to Vibration

Special precautions have been taken to avoid any possibility of interference from the inevitable vibration on large high-powered liners. It is known that contacts closed by light-current relays when in their unoperated positions are much more subject to contact troubles than those closed in the operated position. The circuits of this system and of the fire alarm system have accordingly been designed in such a way that the essential circuit changes occur when a "front" contact, i.e., one which is open when the relay is unoperated, opens or closes. Some of the relays are released by short circuit rather than by opening their circuits, for this reason.

The Service Call System

This installation enables passengers to call stewards and stewardesses directly, without using the telephone.

The passenger depresses a button which lights

a lamp corresponding to the cabin number, on a gangway signal board, the signal being repeated at one or other of the information offices.

First and tourist class passengers can call either a steward or a stewardess, their cabins being provided with two push buttons connected to a 3-wire line. Third class passengers and members of the crew can call a steward only.

When a call lamp lights, it illuminates a portion of a glass panel in the gangway signal board and displays the cabin number where the call has been originated. The colour indicates the service required—green for steward and yellow for stewardess. The gangway signal board is also provided with green and yellow pilot lamps.

In the appropriate information office, a repeat signal board is equipped where all calls are repeated until answered. For example, if a first class passenger in cabin No. 251 calls a stewardess at gangway signal board No. 135, lamp 251 lights yellow and a pilot lamp of the same colour lights at the repeat signal board, displaying the number 135.

The person requested, advised by the signals, the gangway steward, or the information office, goes to the gangway signal board to find out the number of the cabin, depresses a key which cancels the signal, and then proceeds to the cabin in question.

The repeat signal at the Information Office remains alight so long as a signal persists at the gangway signal board, in order that the service may be properly supervised. The repeat signal boards are arranged to indicate clearly in which part of the ship, or on which deck, the different gangway signal boards are located.

Certain signal boards have one or more extra pilot lamps operated from neighbouring boards,

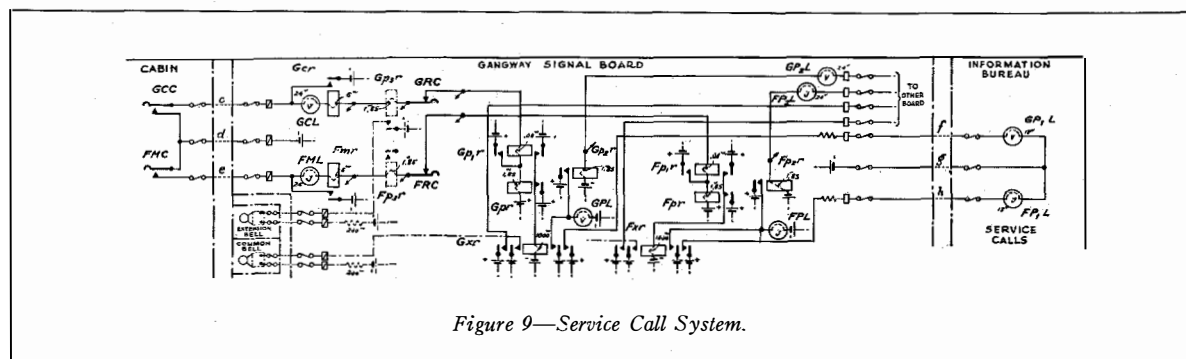

Figure 9—Service Call System.

for both stewards and stewardesses, so that a gangway steward can supervise the service call system for more than one gangway.

The Gangway Signal Board

The signal board consists of an enclosed metal framework sunk into the wall of the gangway with its front surface flush with the wall, the finish corresponding with the wall decoration. The only portion visible is the lamp signal panel consisting of a white glass pane surrounded by a metal frame. This panel is divided into three columns: the centre column is allocated to another signaling system with which we are not here concerned, while the left- and right-hand columns house the service-call signals for stewards and stewardesses, respectively. Behind the panel are lamps which, when alight, display the numbers of the corresponding cabins in colours according to the kind of signal—a green for steward and yellow for stewardess. At the bottom of the left- and right-hand columns are push button keys for canceling the service call signals. Above the signal board is a small panel projecting into the gangway and containing the green and yellow pilot lamps.

Circuit Operation (Fig. 9)

When a passenger requires a steward, he depresses the corresponding button GCC. The line relay Gcr operates at the gangway signal board and locks in series with the lamp GCL (green) which burns steadily. The pilot relays Gpr and Gp_{1r}, also in series, operate as well, and in turn operate the pilot lamp relay Gxr, thereby lighting the pilot lamp GPL, and also

the repeat lamp GP₁L at the board in the information office. Similarly a key, relays, and lamps are provided for calling a stewardess.

If there is a repetition of the call on another gangway signal board, Gxr lights lamp GPL on that board through relay Gp_{2r}. A service call is therefore signaled at the gangway signal board by lamp GPL associated with the particular cabin and by pilot lamp GPL; also, in the Information Office, by GP₁L and, if repeated, on another gangway signal board by lamps GP₂L and GPL.

To cancel the signal the steward depresses key GRC for an instant, whereupon all relays are released, indicating that the call has been attended to.

In all, there are 1,041 steward call circuits and 793 stewardess call circuits, distributed over 79 gangway signal boards. In addition, there are 5 repeat signal boards located, respectively, in the first class, tourist, and third class information offices, and in the information offices on Deck E and the Promenade Deck. These figures indicate the importance of this installation.

The current supply for the service call system is common to the fire detector signaling and the manual fire alarm systems. The installation comprises a cadmium-nickel battery of 335 ampere-hours capacity, two charging sets operated from the ship's 220 volt d-c. mains, and a power board.

The author wishes to express his thanks to the Compagnie Générale Transatlantique (French Line) for permission to reproduce much of the information contained in this article, and to Mr. L. B. Haigh for assistance in its preparation.

Federal District 7-A.2 Rotary Automatic Exchange “48,” Inaugurated June 29, 1935 by the Brazilian Telephone Company*

AS PART of the Brazilian Telephone Company's vast program for the Federal District, its 7-A.2 Automatic Exchange “48” was inaugurated at midnight on June 29, 1935. The inaugural ceremony was simple, and followed the cutover of the new exchange by Mr. José Pinto, representing the Prefect of the Federal District, in the presence of H. L. Banfill, Chief Engineer, A. I. Peterson, Assistant General Superintendent, A. T. dos Santos, Commercial Superintendent, service chiefs, and employees of the company. Imme-

*Translated and reprinted, by permission, from *Sino Azul*, July, 1935, published by Companhia Telefonica Brasileira.

diately thereafter the representative of the Prefect dialed the first call over the network of the new exchange.

The cutover of Exchange “48” was well planned and was completely successful. As a precautionary measure, a methodic and progressive plan of instructions for the subscribers had been adopted:

- (a) A circular letter prepared by the Commercial Department was sent to each subscriber, advising him that his telephone would shortly be switched over from manual to automatic operation, and containing other pertinent information;
- (b) Telephone subscribers were informed by the installers, while the work of replacing the telephone sets was in progress, that the purpose was to fur-



Mr. José Pinto, Representing the Prefect of the Federal District, Dialing the First Call to the Network of the New Exchange. At His Left is Mr. A. I. Peterson, Assistant General Superintendent; at His Right are Mr. Alfredo T. dos Santos, Commercial Superintendent, and Mr. J. Vedey, Plant Superintendent (standing).

- nish subscribers with automatic telephone service;
- (c) Special cards, containing brief but complete instructions on how to use the automatic telephone properly, were printed and sent out a few days before the inauguration of the new exchange, together with the new telephone directory;
 - (d) The Traffic Department telephoned all subscribers affected by the change, to warn them that after a certain hour their telephones would be converted to automatic operation and that thereafter they should use the dial to make calls.

This warning was repeated during the first day after the inauguration. The result was that, unlike experiences on previous similar occasions, there was hardly any need for operators to intercept wrong calls.

The exchange was inaugurated with 4,423 telephones located in Villa Isabel, Andarahy, Tijuca, and Alto da Boa Vista.

Layout and Construction of the Building

The layout of the building is in accordance with modern architectural taste and tendencies, harmonizing well with the neighboring residential structures. It was skillfully planned by H. Maroni, Engineer and Architect, and his engineering staff.

The structure was built with domestic material and by Brazilian labor. It was designed to withstand a load of 650 kilos per square meter of floor space. The foundations were designed to carry two additional stories, which may be added in the future to take care of requirements imposed by the development of the telephone service.

At the present time the building can accommodate a 10,000-line unit. With two additional stories, three complete units of 10,000 lines each, that is, a total of 30,000 lines, can be housed.

The structure was so planned and built that it can, at any time, be equipped with an air conditioning plant.

Outside Plant

In order to divide the existing area of Exchange "28" into two areas, one for Exchange "28," and the other for the new automatic Exchange "48," considerable construction and reconstruction work had to be done on the outside plant. To convey an idea of this work, it will suffice to give

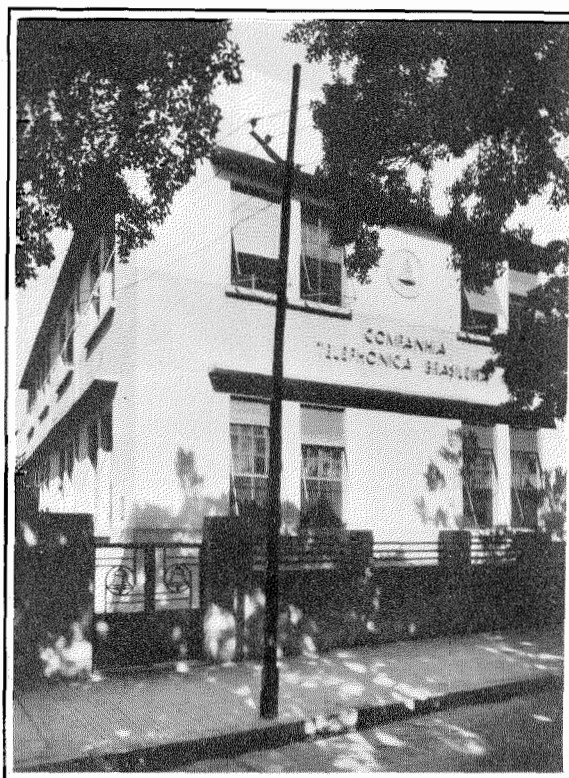

"48" Automatic Exchange, Rio de Janeiro

the following data, concerning the length of the cable and conduit lines:

CONDUIT	
2 duct lines.....	972.60 meters
4 duct lines.....	3,219.85 meters
6 duct lines.....	1,319.70 meters
8 duct lines.....	1,207.85 meters
12 duct lines.....	806.50 meters
16 duct lines.....	28.90 meters
26 duct lines.....	165.60 meters
32 duct lines.....	150.10 meters
36 duct lines.....	292.45 meters
Total.....	8,163.55 meters

CABLES	
23,783,020 meters of 24 gauge cable, varying in size from 26 to 1,212 pairs.	
17,228,000 meters of 22 gauge cable, varying in size from 26 to 909 pairs.	
23,483 meters of 19 gauge cable, varying in size from 26 to 455 pairs.	

In addition to the foregoing, innumerable rearrangements were made on the existing cables of both areas (28 and 48), in order to provide

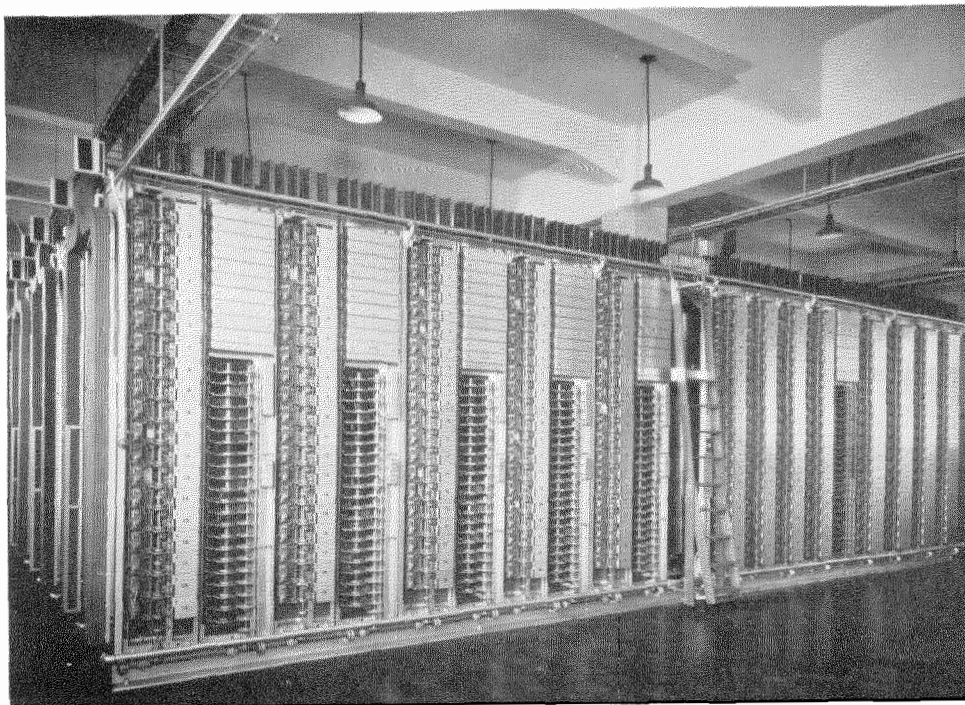

Line Finders and Final Selectors.

facilities in the cables, the capacity of which had been practically exhausted.

Replacement of Telephone Sets

In the subscribers' premises the 4,423 manual telephones were replaced with telephones equipped with dials, and a thorough inspection was made of every installation, from the cable terminal on the pole to the telephone set itself. The inside wires and the drop wires were replaced in a large number of cases.

Exchange Equipment

The exchange was inaugurated with equipment for 6,000 lines, 4,423 of which were placed in service on the night of the inauguration. Its ultimate capacity is a complete unit of 10,000 lines, or 8,000 local subscriber lines and a satellite exchange of 2,000 lines.

It is the intention, for technical reasons, to transfer satellite Exchange "29-6" from Exchange "29" to Exchange "48." With this plan in mind, the equipment and the circuits of Exchange "48" were designed for connection with the satellite exchange.

Exchange "48" comprises the following equipment:

- 5,900 Line and cut-off relays.
- 653 First line finders.
- 75 Second line finders.
- 540 First group selectors.
- 161 Call finders.
- 165 Register finders.
- 100 Registers.
- 320 Local third group selectors.
- 720 Incoming third group selectors.
- 50 Third group selectors for special and toll service.
- 480 Fourth group selectors.
- 570 Final selectors.
- 1 Power board.

As previously mentioned, the equipment is of the 7-A.2 type, which embodies several improvements over the 7-A.1 type. These improvements may be summarized as follows:

LINE FINDERS

7002 Used in 7-A.1	7100 and 7200 Used in 7-A.2	Improvements of the New System over the 7002
Punched frame.	Diecast frame.	More rigid construction.
Double coil clutch mounted on the bay.	Single coil clutch mounted on the machine.	Space saving; greater accuracy in adjustment.
To take brush carriage out feeder brush must be removed.	Feeder brush pivots on a pin.	Facilitates removing brush carriage and inspection of feeder tips when required.
Gear located below frame.	Gear located above extending portion of frame.	Better protection of gear.
Clutch adjustment made by bending armature spring.	Clutch adjustment controlled by screw and nut.	Ease of adjustment.
Drive fixed by screws.	Drive fixed with conical sleeve.	Less eccentricity of drive; more reliable fixing on the shaft.
Certain unit assemblies could not be taken out without removing screws.	All unit assemblies can be taken out without removing screws.	Facilitates maintenance.

SELECTORS

7009 Used in 7-A.1	7120 Used in 7-A.2	Improvements of the New System over the 7009
Punched frame and brush carriage.	Diecast frame and carriage.	More rigid construction.
Clutch mounted on bay framework; adjustment necessary to assemble component parts of machine.	Clutch mounted on selector frame; setting of different moving parts automatically controlled by pivot permanently fixed in the frame.	Saving in space; simple assembly and adjustment.
Removing brush carriage required removal of other parts.	Brush carriage pivots on shaft unit.	Facilitates removal.
Two gears required to drive the trip spindle.	Trip spindle is driven by a single gear.	One less gear required.
Hard rubber block not readily removed.	Each hard rubber block fits over a common pin.	Individual blocks can be removed without disturbing brush carriage.
Trip spindle brake on driving gear.	Brake contacts directly on trip spindle gear.	Any possibility of backlash eliminated.
Separate shaft used to drive selector.	Single shaft drives both selector and sequence switch.	Less equipment required; saving in space.
Traffic counts made on separate equipment.	Mechanical counters can be mounted directly on machine.	Simplifies traffic studies.
Collector ring mounted on underside of machine frame.	Collector ring mounted on brush carriage.	Facilitates inspection and maintenance.
Clutch adjustment made by bending armature spring.	Clutch adjustment controlled by screw and nut.	Ease of adjustment.
Certain unit assemblies could not be taken out without removing screws.	All unit assemblies can be taken out without removing any screw.	Facilitates maintenance.

SEQUENCE SWITCHES

7011 Used in 7-A.1	7101 Used in 7-A.2	Improvements of the New System over the 7011
Clutch mounted separately on bay.	Clutch mounted directly on switch frame.	Saving in space; facility in assembling.
Square shaft.	Heavy round shaft.	Less tendency for distortion during cam assembly; concentricity of cams improved.
Blade type armature spring.	Spiral type armature spring with screw adjustment.	Easier to adjust.
Indicator wheel.	Transparent indicator.	Position indication improved.

In addition to the foregoing, the switches are smaller in size and 1,275 fewer are required for an equivalent 10,000-line unit, which results in considerable reduction of space and maintenance expense.

Features of Circuits

Subscriber Line Circuit

The equipment is designed to operate with a maximum total loop resistance of 1,400 ohms and with a minimum insulation resistance of 10,000

ohms. It is arranged to function with a false call and malicious call finder, mounted on the same bay and multiplied with the line finders. It is also arranged for signaling restricted service to the registers over the metering brush of the line finder.

First Group Selector Circuit

Included in the first group selector circuit are a group selector, a sequence switch, and eight relays.

In operation, the line finder is controlled by a test relay over a normal position of a sequence switch associated with it or connected via a second line finder. If two line finders stop on the same line at the same time, a helping relay ensures that only one of the first group selector circuits shall continue to handle the call.

The circuit checks the continuity of the wires "a," "b," and "c" before extending the connection to the ringing circuit. If the circuits of these wires are not completed, the connection is released by means of a timing device. It extends the call to a register and an idle trunk, and makes subsequent selections, including interurban, rural, restricted and special service, false and malicious calls, as well as providing ringing signals and discriminating tones, single counting on ordinary calls, multiple and repeated counting, and coin collection facilities.

Register Circuit

The register circuit of the 7-A.2 system differs from its predecessor mainly in the design of the impulse receiving (insteping) circuit. Only one set of impulse counting relays receiving all digits was provided for this purpose. In the interval

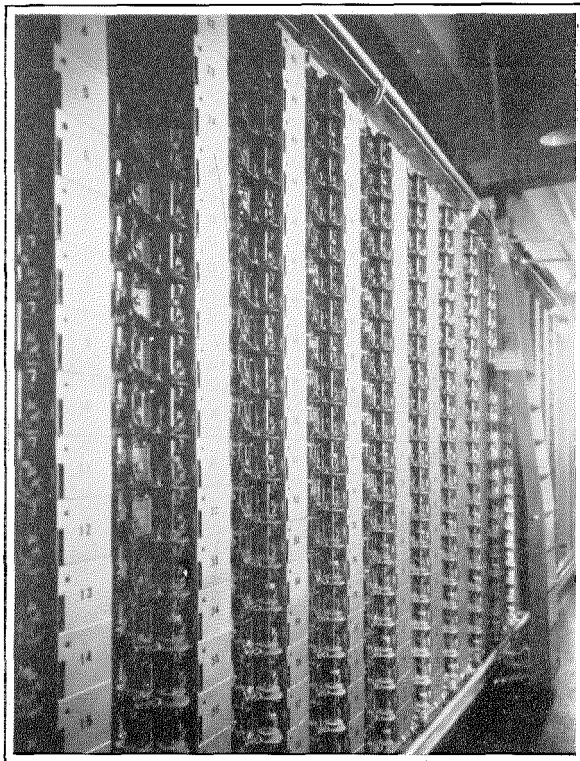

Group Selectors.

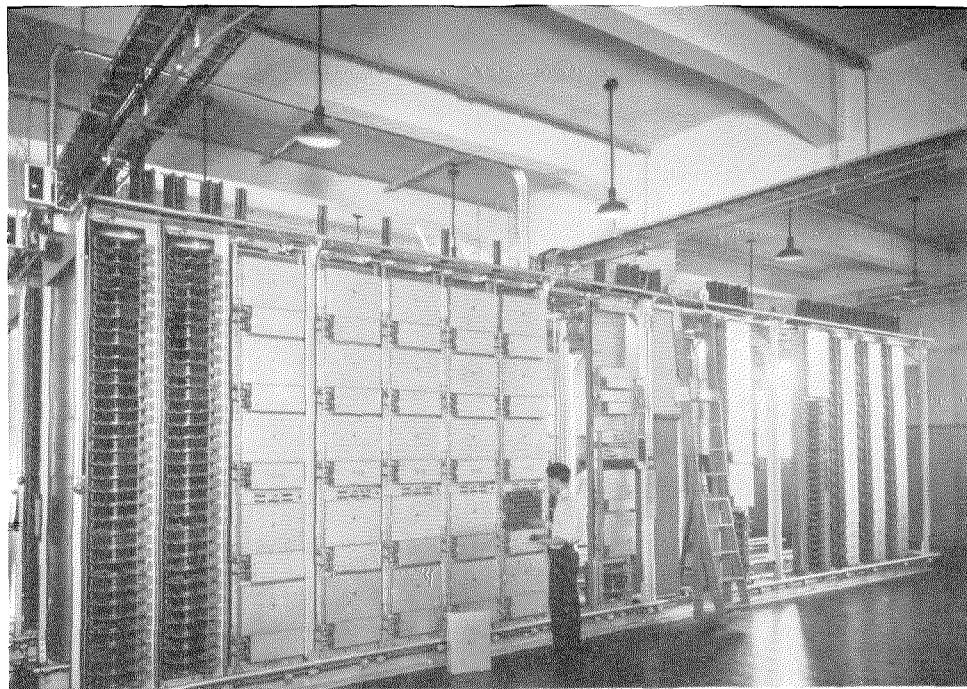

Register Finders and Registers.

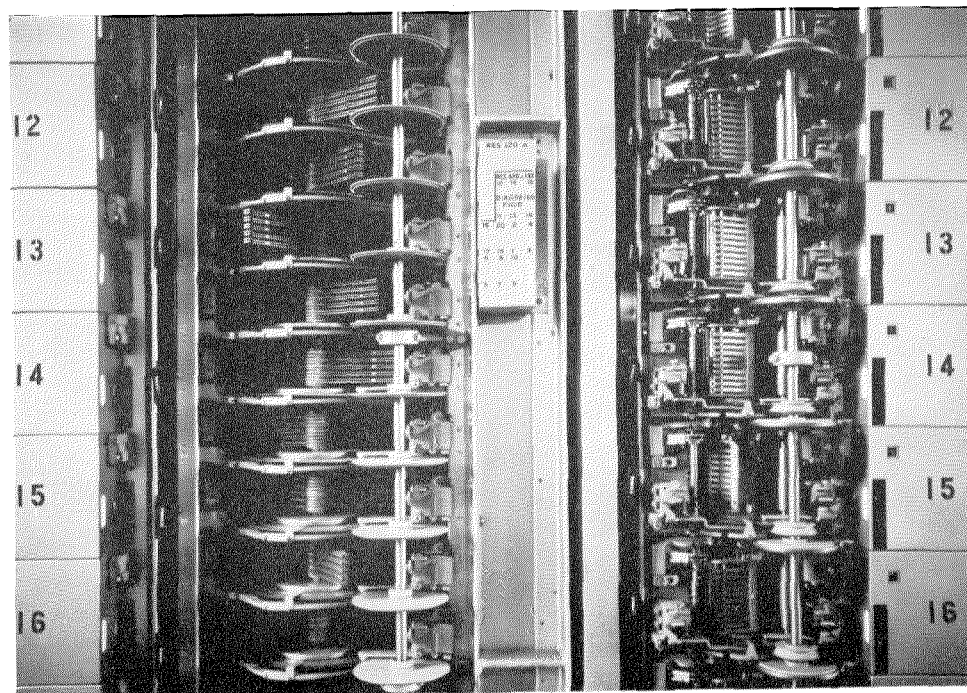

Group of Selectors.

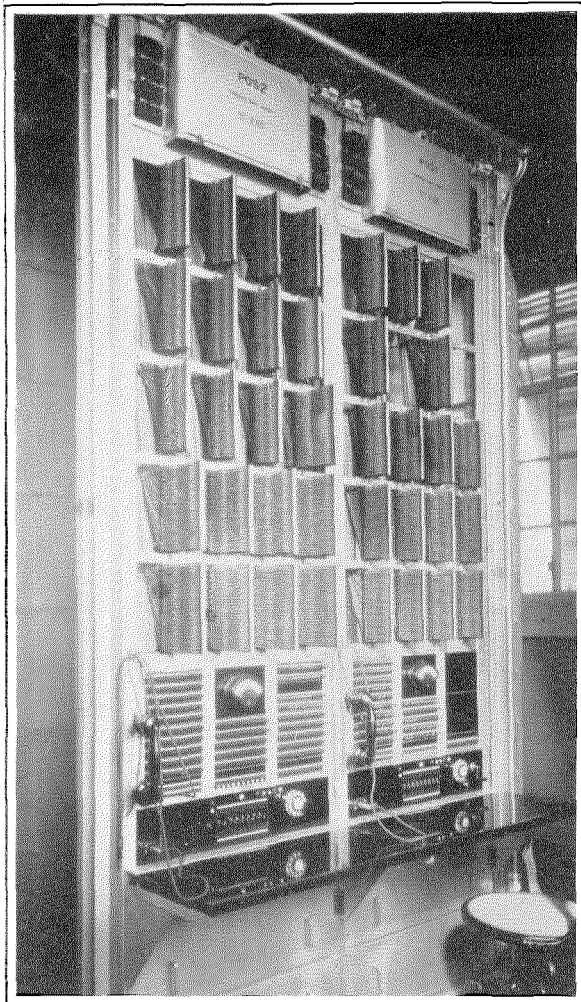

Test Desk for Outgoing Trunks.

elapsing between each digit, a record of the number of impulses received is transferred to a set of four impulse storing relays and the counting relays are released in readiness to receive the impulses of the following digits.

Intermediate Selectors

The second and third group selectors, both local and incoming, require no description. They consist of regular selectors, sequence switches, and a number of relays, depending on the type of circuit.

Fourth Group Selector

The fourth group selector, in conjunction with a sequence switch and four relays (one additional for toll), and under the control of a register cir-

cuit, selects one of ten levels of arc terminals and hunts for a free trunk in that level leading to a final selector. It is designed so as to supply ringing current to the called line and ringing tone to the telephone of the calling subscriber, as well as busy tone if the line is busy, and dead tone if the line is dead. In Exchange "48" the busy tone is also used for dead lines.

Final Selectors

The final selector, in conjunction with a sequence switch and three relays controlled by a register circuit, selects the terminals of the called line and completes the connection if the called line is free. If the called line is busy, or dead, the final selector signals the fourth selector to supply the proper tone to the calling subscriber.

The connecting terminals between the final selector and the first line finders were omitted; the arc terminals of the final selectors are connected by means of cables to the arc terminals of the first line finders.

The old special P.B.X. groups were also

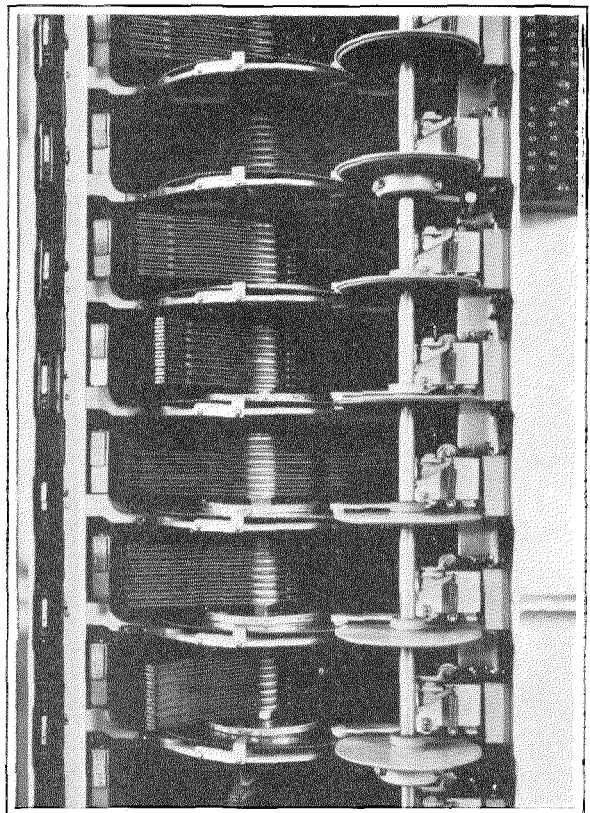

First and Second Line Finders.

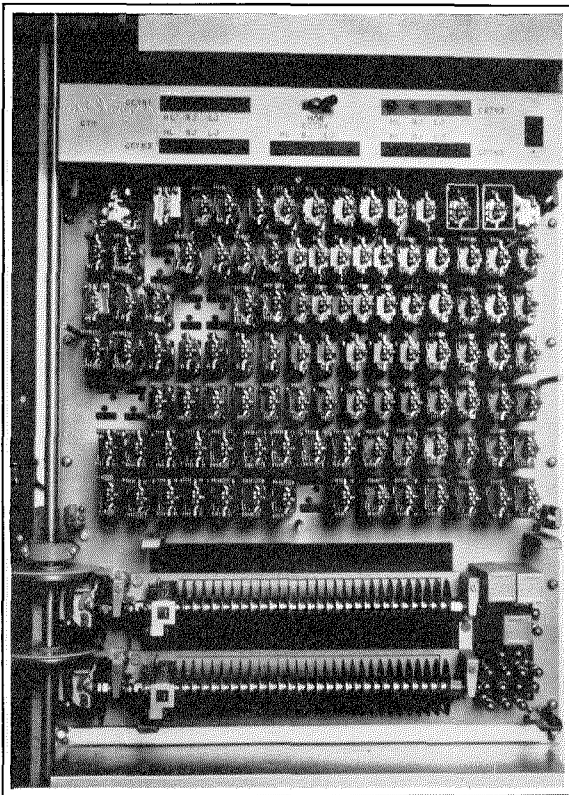

Relays and Sequence Switches.

omitted. A P.B.X. group can be made in any line group by placing resistances in parallel with the cut-off relays of predetermined lines of a group.

False Call Device

Among the many new devices introduced, the false call device may be regarded as of great value as a time saver for the maintenance staff.

If a subscriber removes the receiver from the hook and fails to dial, his line is connected to a false call finder after an interval of about 30 seconds. If the receiver is still off the hook after an interval of about 10 minutes, the call is transferred to the test desk over a master circuit. At the test desk the number of the line is projected on an indicator panel, similar to the projection panel of the call indicator. When the tester sees the number projected, he can test the line over an associated jack circuit and apply the howler signal.

If the trouble is other than the receiver being off the hook, or the subscriber fails to answer the howler signal, the repairman can place the line out of service by inserting wooden plugs in the corresponding jacks and arrange for the correction of the trouble.

The panel is provided with a special key

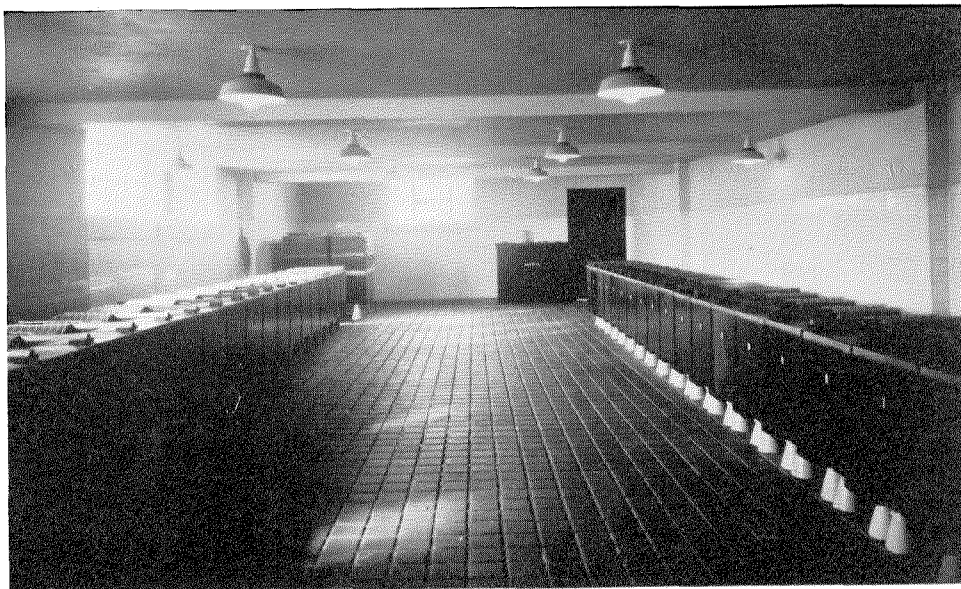

Battery Room.

whereby the numbers projected on the indicator can be made to disappear at will.

The equipment for Exchange "48" was

supplied by the International Standard Electric Corporation and constructed in its Antwerp factory.

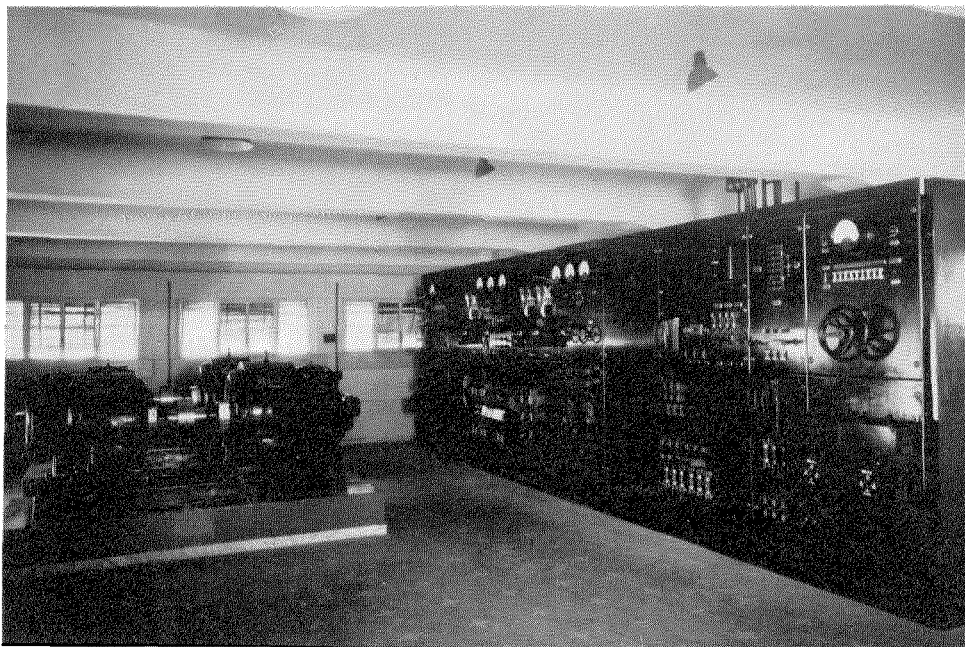

Power Room.

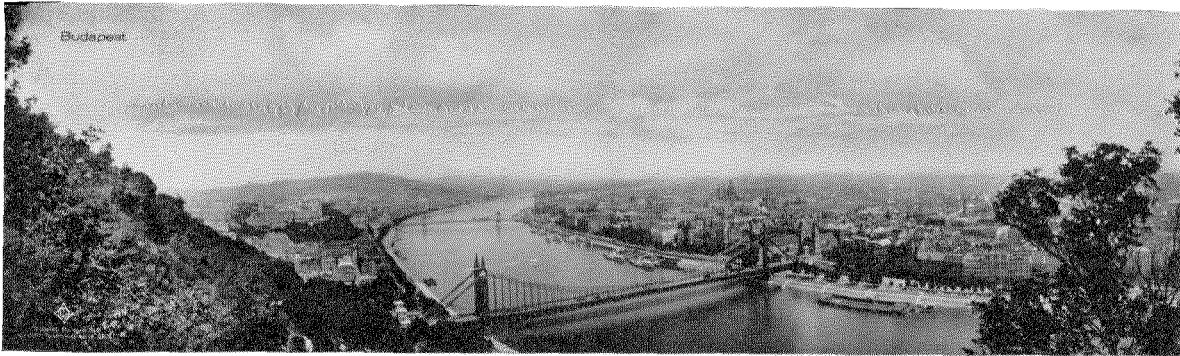

Budapest.

Teréz Automatic Exchange—Budapest Area 20,000 Lines in One Room

By J. SAROSPATAKY

Engineer, Royal Hungarian Telephone Administration

THE conversion of the Budapest area from manual to full automatic working was accomplished in a relatively short time. A description of the development of the Budapest area and its conversion from manual to automatic service has been given in *Electrical Communication*¹. The first cutover of an automatic exchange took place in March, 1928, and the last manual exchange in the area was converted to full automatic working late in 1932.

All exchanges are of the 7-A.1 Rotary type and were engineered, manufactured, and installed by the Standard Villamossági Részvény Társaság, Budapest. In all—sixteen exchanges—main and satellites—are now in service with a total equipment for 75,000 lines.

An interesting problem, from an engineering point of view, came up when the planning of the conversion of the Teréz exchange was started. This exchange, the largest in the Budapest area, is located on the Pest side of the Hungarian capital. The old manual Teréz exchange consisted of two units, one equipped with 16,000 subscribers' lines, and the other with 6,000 lines.

¹"Budapest Telephone Area—Development and Transition from Manual to Automatic," by Janó Rédl, *Electrical Communication*, April, 1929.

Both of these manual exchanges were located in the same building, the former in a large hall, 63.75 meters long, 10 meters wide, and 7 meters high. The first problem encountered was how to free the hall for the installation of the automatic exchange without interrupting the telephone service given to the subscribers.

A temporary automatic exchange, with the equipment located in several small rooms previously used as offices, was installed. The temporary exchange consisted of calling equipment for 10,000 lines, but answering equipment (final selectors) was installed for 16,000 lines. The multiple on the arcs of these final selectors was cabled in parallel to the multiple of the 16,000 line manual exchange. Thus, changes in subscribers' numbers during the conversion period were avoided. After the installation of the temporary automatic exchange, the manual boards (Fig. 1) were removed from the large hall.

The second problem was how to utilise fully the space available in this hall. The ceiling height, 7 meters, would have resulted in a waste of space if the regular height of switchrack had been adopted. It was, therefore, decided to install the equipment in two levels. The floor was reinforced to take care of the additional weight. The

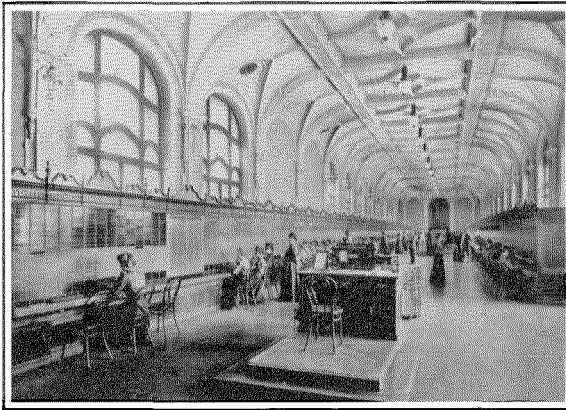

Figure 1—Teréz Manual Common Battery Exchange—
16,000 Lines.

cross beams in the floor were located to correspond exactly with the spacing of the floor channels of the switchracks, placed directly on the floor.

Contrary to the usual practice, terminal strips are not provided on top of the selector bays. The required terminals are located in a special terminal room directly below the switchroom. This room was previously occupied by the relay equipment of the manual exchange. The cabling between the selector bays and the terminals is brought through holes in the floor. These holes

were provided when laying the floor and are spaced to correspond to the location of the selector bays. When designing the terminal racks, attention was directed towards obtaining the most economical cabling layout. One terminal rack serves twelve selector bays, the terminals being so placed that the cross connections can be made by simple straps. A further advantage of this terminal room is that the subscribers' cabling of the old exchange could be utilised for the automatic exchange.

Three uprights per row of the lower level switchracks are extended above the roofing of these racks. These uprights carry a wooden platform on an iron frame. On this platform, low sized switchracks, 2.80 meters high, are placed; these latter racks run lengthwise. Access to the platform is given by stairways located at each end of the platform. Vertical ladders are further located at suitable intervals in the gangway on the floor. The arrangement of the two levels of switchracks is shown in Fig. 2.

The layout of the switchracks is shown in Figs. 3 and 4. Fig. 3 gives the details of the equipment located on the lower level of switchracks, while Fig. 4 indicates the distribution of the equipment on the racks located on the platform.

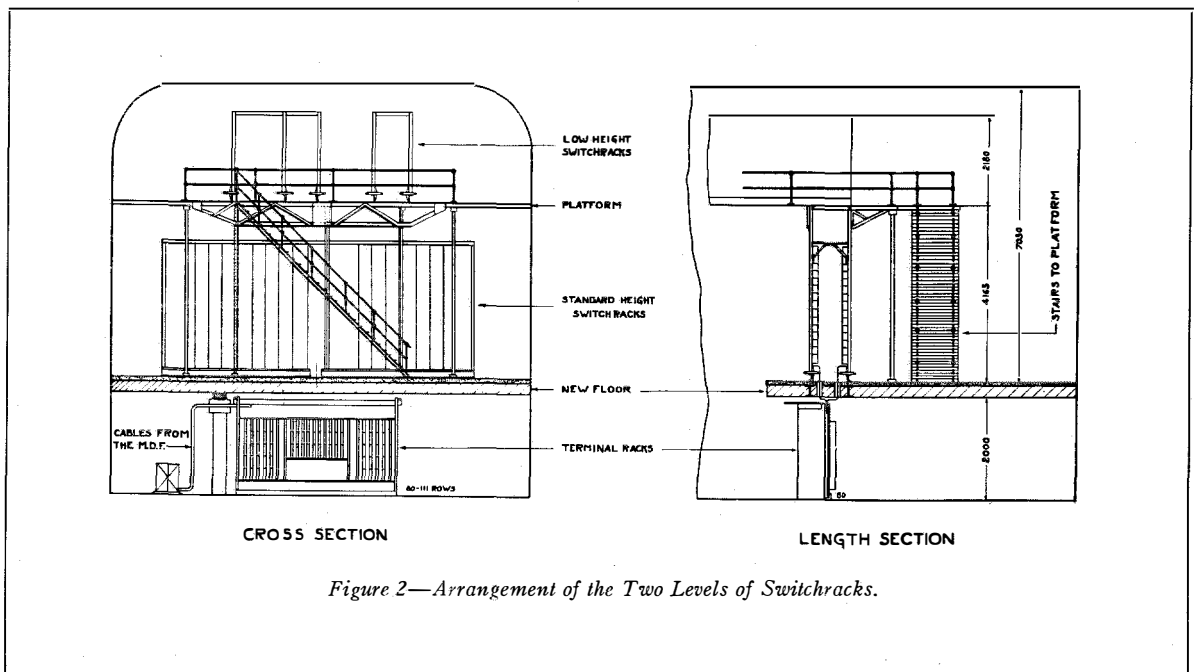

Figure 2—Arrangement of the Two Levels of Switchracks.

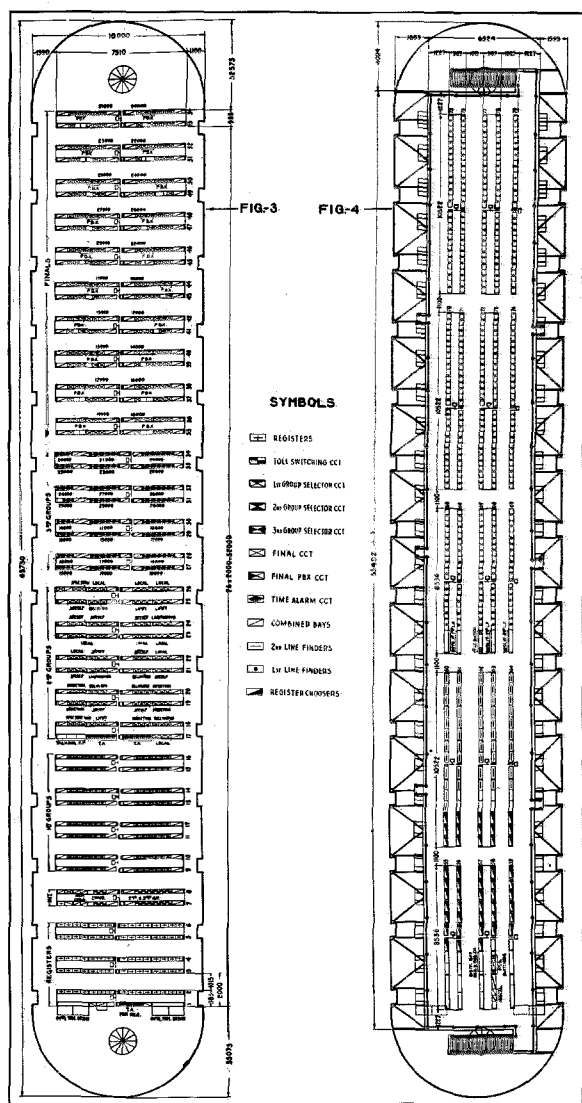

Figure 3—Layout of Lower Level of Switch racks.

Figure 4—Layout of Upper Level of Switch racks.

When allocating the equipment on the different racks, it was found advantageous to place the selector type and register circuits on high type racks located on the floor, and the finder type circuits, 1st line finders, 2nd line finders, and register finders on the racks on the platform.

The distribution of the automatic equipment on the lower level switch racks (Fig. 3) is as follows:

- Finals: 10 m. double rows, each with 2,000 lines, rows 35 to 54
- 3rd Group Selectors: 8 rows, 27 to 34

- 2nd Group Selectors: rows 17 to 26
- 1st Group Selectors: rows 9 to 16
- Toll Switching Circuits: rows 7 and 8
- Registers: rows 2 to 6

Out junction test frames and time alarm interrupter registers on row 1.

The time alarm interrupters for the 1st group selectors are located in row 17.

The floor space occupied by the switch racks is about 400 m².

In Figs. 5 and 6 are shown views of the machine switching room of the Teréz Automatic Exchange.

The manner in which an existing room, designed for a manual exchange, has been utilised for the erection of a rotary automatic exchange, has not been encountered elsewhere. A simple cable plan with relatively short cable runs has been achieved, and the maintenance of the exchange facilitated.

A discussion of maintenance and fault statistics relating to the exchange is not within the

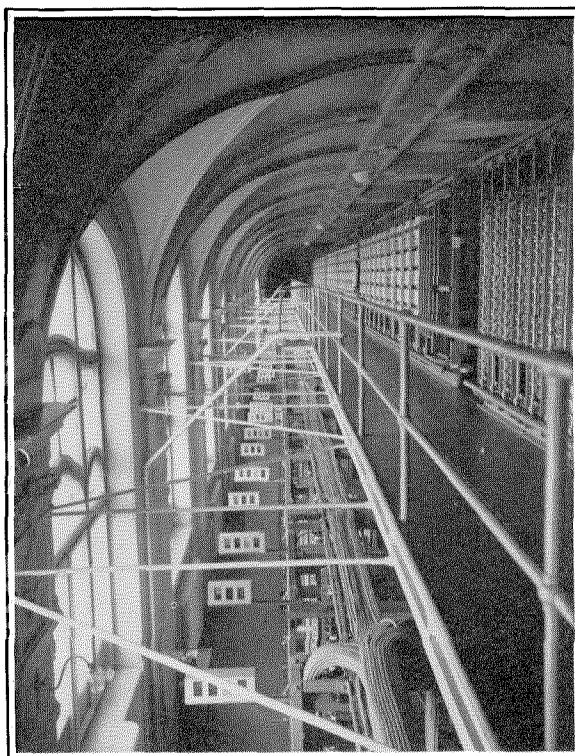

Figure 5—Teréz Automatic Exchange—Machine Switching Room, Upper Level.



Figure 6—Teréz Automatic Exchange—Machine Switching Room, Lower Level.

scope of this article. It is, however, worth mentioning that amongst the facilities developed by the author there is a circuit called "direct routiner." This circuit is contained in a box and consists of a small number of relays, keys, and lamps. It can, by means of a cord and plug, be connected to any group selector. By depressing

a combination of keys, a number is sent out and selections are made in predetermined directions. This device provides simple means for facilitating the work of the maintenance men when locating faults and has proved especially valuable in locating certain faults during periods of heavy traffic.

Notes on Piezoelectric Quartz Crystals*

By ISSAC KOGA

Tokyo University of Engineering, Tokyo, Japan

EDITOR'S NOTE: *This paper, the most recent contribution on Crystals, is reprinted, by permission, from the March, 1936 issue of the PROCEEDINGS OF THE INSTITUTE OF RADIO ENGINEERS. Development in this general field has been carried on principally in Germany, Great Britain, Japan, and the United States of America. For other papers on this important subject the reader is referred to the following: "Some Improvements in Quartz Crystal Circuit Elements," by F. R. Lack, G. W. Willard, and I. E. Fair, THE BELL SYSTEM TECHNICAL JOURNAL, July, 1934; "Crystal Oscillators for Radio Transmitters," by C. F. Booth and E. J. C. Dixon, THE JOURNAL OF THE INSTITUTION OF ELECTRICAL ENGINEERS, August, 1935; "Messung der Schallgeschwindigkeit in anisotropen Medien, insbesondere in Quarz mittels piezoelektrischer Erregung," by R. Bechmann, ZEITSCHRIFT FÜR PHYSIK, (Vol. 91), Oct. 14, 1934; "Schwingungsform und Temperaturkoeffizient von Quarzoszillatoren," by Harald Straubel, ZEITSCHRIFT FÜR HOCHFREQUENZTECHNIK, Vol. 38, No. 1 (July, 1931).*

SUMMARY—*The chief characteristics of quartz plates cut at various angles to the crystal axes are described, with particular attention to the effect of temperature on frequency of oscillation. Methods of reducing these temperature effects lead to the manufacture of zero temperature coefficient plates. Their application to existing transmitters previously employing X-cut plates is described. Particularly stable oscillators using two crystals in a single circuit are also described.*

I. Vibration of Piezoelectric Crystal Plate

WHENEVER there is an electrically maintained vibration in such an oscillator as the Pierce circuit, by employing a sufficiently thin piezoelectric crystal plate bounded by two principal parallel planes in an arbitrary orientation referred to the original crystal form, the period of vibration is either

(1) dependent only upon the thickness of the plate and not upon the form and dimensions of the contour of the principal surfaces (*thickness vibration*) or

(2) dependent only upon the form with its orientation to the original crystal axes and dimensions of the contour of the principal surfaces and not upon the thickness (*contour vibration*¹).

This fact is easily verified in, for example, quartz, tourmaline, cane sugar, tartaric acid, Rochelle salt, sodium chlorate, etc.²

* Decimal classification: R355.65. Original manuscript received by the Institute, May 16, 1935; revised manuscript received by the Institute, July 15, 1935. Presented before Tenth Annual Convention, Detroit, Mich., July 1, 1935.

¹ This name is tentatively given by the writer for the sake of convenience. Some German writers say "Querschwingung."

² I. Koga and T. Nakamura, "Measurement of the Elastic Constants of Cane Sugar, Tartaric Acid, Rochelle

It is well known that sometimes these two kinds of vibrations are observed to be coupled with each other mechanically,³ or electrically, or mechanically and electrically, but as this is a secondary phenomenon we will not consider it further in this paper.

Now if the principal surfaces of a crystal plate extend to infinity, that is, if a crystal be bounded only by two infinite parallel planes, then frequencies and modes of vibrations can be completely calculated.

As a free elastic vibration is nothing but a system of standing waves produced by the interference of two *similar* waves propagated in *opposite* directions, no waves other than plane waves, the wave fronts of which are exactly parallel to the boundary surfaces, can contribute to the production of standing waves in such a plate, for if a wave front be not plane the wave produced by reflection at a plane boundary surface cannot be *similar* to the incident wave, while a plane wave, the wave front of which is not

Salt, and Natrium Chlorate by means of Piezoelectric Vibration," Supplementary Issue, *Jour. I.E.E. (Japan)*, p. 134, April, (1933).

³ F. R. Lack, "Observations on Modes of Vibrations and Temperature Coefficients of Quartz Plates," *Proc. I.R.E.* vol. 17, p. 1123-1141; July, (1929); *Bell Sys. Tech. Jour* vol. 8, p. 515; July, (1929).

TABLE I
VALUES OF c 's IN THE FREQUENCY EQUATION (1) FOR DIFFERENT ORIENTATIONS OF CRYSTAL CUT

θ	-30° and 90°	$-25^\circ, 85^\circ,$ and 95°	$-20^\circ, 80^\circ,$ and 100°	$-15^\circ, 75^\circ,$ and 105°	$-10^\circ, 70^\circ,$ and 110°	$-5^\circ, 65^\circ,$ and 115°	$0^\circ, 60^\circ, 120^\circ,$ and 180°	θ
0°	105.67 57.09 57.09	105.67 57.09 57.09	105.67 57.09 57.09	105.67 57.09 57.09	105.67 57.09 57.09	105.67 57.09 57.09	105.67 57.09 57.09	180°
15°	110.76 59.10 47.44	110.74 59.20 47.41	110.56 59.31 47.42	110.28 59.91 47.11	109.94 60.47 46.88	109.55 61.10 46.64	109.11 61.78 46.40	165°
30°	121.94 50.38 37.99	121.87 50.49 37.94	121.24 51.25 37.81	120.21 52.44 37.64	118.95 53.90 37.45	117.14 55.86 37.31	115.21 57.91 37.18	150°
45°	129.06 40.46 31.23	128.69 40.70 31.37	127.59 41.39 31.77	125.80 42.56 32.38	123.36 44.26 33.14	120.35 46.46 33.94	116.87 49.13 34.74	135°
60°	127.27 34.93 28.99	125.74 37.03 28.42	124.41 36.87 29.91	122.10 37.98 31.10	119.00 39.34 32.85	115.13 40.90 35.16	110.64 42.52 38.03	120°
75°	113.33 39.01 31.86	112.53 40.33 31.34	111.37 42.49 30.34	109.00 45.54 29.64	105.78 48.83 29.59	101.84 52.13 30.23	97.30 55.27 31.63	105°
90°	93.32 49.22 39.10	92.93 50.99 37.72	91.84 54.71 35.09	90.17 58.90 32.57	88.12 62.90 30.62	86.26 65.99 29.39	85.45 67.22 28.98	90°
105°	75.44 60.02 48.74	76.16 60.91 47.13	78.56 61.92 43.73	82.48 61.69 40.01	87.31 60.28 36.62	92.37 58.05 33.78	97.30 55.27 31.63	75°
120°	84.97 48.01 58.21	86.48 47.80 56.91	90.25 47.22 53.72	95.12 46.25 49.81	100.42 44.54 46.23	105.68 44.17 41.34	110.64 42.52 38.03	60°
135°	98.33 37.45 64.97	99.29 37.43 64.13	101.74 37.12 61.88	105.18 36.70 58.86	109.08 36.16 55.53	113.05 35.49 52.20	116.87 49.13 34.74	45°
150°	106.15 36.95 67.21	106.52 36.95 66.82	107.95 35.99 65.36	109.17 36.99 64.14	111.00 37.12 62.18	113.16 37.09 60.06	115.21 57.91 37.18	30°
165°	105.70 47.28 64.32	107.41 45.65 64.23	107.59 45.72 63.98	107.89 45.83 63.58	108.25 45.99 63.05	108.67 46.18 62.44	109.11 61.78 46.40	15°
180°	105.67 57.09 57.09	105.67 57.09 57.09	105.67 57.09 57.09	105.67 57.09 57.09	105.67 57.09 57.09	105.67 57.09 57.09	105.67 57.09 57.09	0°
	30° and 150°	$25^\circ, 35^\circ, 145^\circ,$ and 155°	$20^\circ, 40^\circ, 140^\circ,$ and 160°	$15^\circ, 45^\circ, 135^\circ,$ and 165°	$10^\circ, 50^\circ, 130^\circ,$ and 170°	$5^\circ, 55^\circ, 125^\circ,$ and 175°	$0^\circ, 60^\circ, 120^\circ,$ and 180°	θ

$c = (\text{value given in the table}) \times 10^{10} \text{ dynes/cm}^2.$

parallel to the boundary surface, is not reflected in the direction exactly *opposite* to the incident wave.

The general solution⁴ from the above consideration, available for a plate cut in any orientation from any crystal, gives the following important conclusions:

(1) A crystal plate of infinite extension has three and only three modes of thickness vibration with corresponding fundamental frequencies expressed in the form

$$f = \frac{1}{2a} \sqrt{\frac{c}{\rho}} \quad (1)$$

where a is the thickness and ρ is the density of the plate.

Three values of c 's (adiabatic elastic constants) as well as the directions of displacements can be evaluated if the orientation of the principal planes of the plate be given.

(2) If a sufficient strain in any one of the three modes of thickness vibration can be produced by an electric field normal to the principal surfaces, then that mode of thickness vibration may be realized in an oscillator such as the Pierce circuit.

⁴ I. Koga, "Thickness Vibrations of Piezoelectric Oscillating Plates," Supplementary Issue, *Jour. I.E.E. (Japan)*, p. 33, April, (1932); *Jour. I.E.E. (Japan)*, vol. 52, no. 6, p. 498; June 10, (1932); vol. 52, no. 9, p. 736; September 10, (1932); *Physics*, vol. 3, p. 70; August, (1932); *Rep. Radio Researches*, vol. 2, p. 157; September, (1932); *Phil. Mag.*, vol. 16, p. 275; August, (1933).

(3) The well known fact that sometimes several mechanical vibrations at frequencies very close to the value given by (1) happen to appear, is surely due to the finiteness of the principal surfaces of the plate provided that the two principal surfaces are sufficiently parallel.

(4) Table I shows the values of the c 's for quartz plates of various orientations. This table is based on the following values of adiabatic elastic constants⁵

$$\left. \begin{aligned} c_{11} &= 85.45 \times 10^{10} \text{ dynes/cm}^2, \\ c_{12} &= 7.26 \times 10^{10} \text{ dynes/cm}^2 \\ c_{33} &= 105.67 \times 10^{10} \text{ dynes/cm}^2, \\ c_{13} &= 14.37 \times 10^{10} \text{ dynes/cm}^2 \\ c_{44} &= 57.09 \times 10^{10} \text{ dynes/cm}^2, \\ c_{14} &= -16.87 \times 10^{10} \text{ dynes/cm}^2 \end{aligned} \right\} \quad (2)$$

used in the relations between stresses and strains

$$X_x = c_{11}e_{xx} + c_{12}e_{yy} + c_{13}e_{zz} + c_{14}e_{yz}, \text{ etc.}, \quad (3)$$

the relation of coordinate axes to the crystal form of quartz being shown by Fig. 1. Although there are two kinds of quartz crystals, namely, right-handed and left-handed, we need not distinguish between them as far as the present paper is concerned, since the same mathematical expressions are always available for both right-handed and left-handed quartz, as long as we relate the coordinate axes to the crystal faces r , r' , and m as shown in Fig. 1.

⁵ W. Voigt, "Lehrbuch der Kristallphysik," pp. 754 and 789, (1928).

In Table I, θ and ϕ denote the colatitude and longitude of a normal to the principal surfaces and are given by the following relations with the direction cosines l, m, n . (See also Fig. 2.)

$$l = \sin \theta \cos \phi, \quad m = \sin \theta \sin \phi, \quad n = \cos \theta. \quad (4)$$

For example, the values of the c 's for the plate cut normally to the direction ($\theta = 75^\circ, \phi = 90^\circ$)

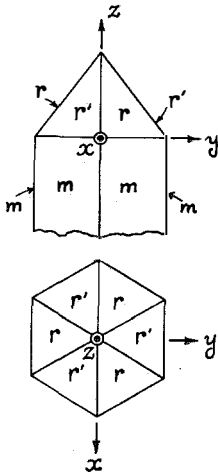

Figure 1—Relation of Coördinate Axes to the Crystal Form of Quartz.

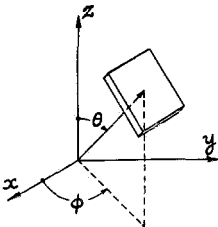

Figure 2—Relation Between Rectangular Coördinates and Polar Coördinates for the Normal to a Crystal Plate.

are 113.33×10^{10} dynes/cm², 39.01×10^{10} dynes/cm², and 31.86×10^{10} dynes/cm², and the values for the plate cut normally to the direction ($\theta = 60^\circ, \phi = 15^\circ$) are 95.12×10^{10} dynes/cm², 46.25×10^{10} dynes/cm², 49.81×10^{10} dynes/cm².

Figs. 3, 4, and 5 show, respectively, the distribution of c 's corresponding to $\phi = 90^\circ, \phi = 65^\circ$, and $\phi = 60^\circ$. The curved surfaces generated by the continuous values of c 's touch at $\theta = 0^\circ$ and $\theta = 180^\circ$, and at $\theta \approx 90^\circ \pm 35^\circ$ when $\phi = 0^\circ, 60^\circ$, and 120° . All values of c 's are symmetrical with respect to the planes of $\phi = 0^\circ, 60^\circ$ and 120° .

(5) In a quartz plate cut perpendicular (X -cut, $\theta = 90^\circ, \phi = 0^\circ, 60^\circ$, or 120°) or parallel ($\theta = 90^\circ, \phi = -30^\circ, 30^\circ$, or 90°) to one of the

three electrical axes, only one mode of thickness vibration can be realized, in which the displacement at any point is always in the direction of that electrical axis.

The fundamental frequency of vibration for the latter (Y -cut) is given by (1) where

$$c = \frac{1}{2} (c_{11} - c_{12}) \sin^2 \theta + c_{44} \cos^2 \theta + c_{14} \sin 2\theta \quad (5)$$

$$\rho = 2.654 \text{ gram/cm}^3.$$

These values are tabulated in the third column of each bracket in Table I, and are also shown in Fig. 3.

As a Y -cut plate corresponds to $\theta = 90^\circ$ in this group, its fundamental frequency can be obtained by putting the value 39.10×10^{10} dynes/cm² in place of c in (1). Thus,

$$f = \frac{1}{a} \times 0.192 \times 10^6 \text{ cycles.} \quad (6)$$

For an X -cut plate (first column of last bracket in Table I), $c = c_{11} = 85.45 \times 10^{10}$ dynes/cm² so that

$$f = \frac{1}{a} \times 0.284 \times 10^6 \text{ cycles.} \quad (7)$$

(6) In a tourmaline plate cut normally to the principal axis Z , only one mode of thickness vibration can be realized, in which the displacement at any point is always in the direction of the principal axis (longitudinal vibration) and the frequency is given by

$$\frac{1}{2a} \sqrt{\frac{c_{33}}{\rho}} = \frac{1}{a} \times 0.360 \times 10^6 \text{ cycles.} \quad (8)$$

II. Quartz Plates of Zero Temperature Coefficient for Short Wave Oscillators

We do not doubt the established fact that a valve-maintained quartz oscillator is the most satisfactory apparatus for producing high-frequency alternating currents of extremely stable frequency. Recently the practice has been to place quartz plates in thermostatically controlled compartments in order to eliminate even the minor effect of temperature upon the oscillating frequency of quartz. This procedure, however, results in a number of inconveniences. Since it appeared possible to eliminate the effect of temperature variation on the frequency of quartz,

we hoped to dispense completely with the necessity of temperature control. Having this in mind, we first performed the following experiment. The idea on which it was based was very simple. Since it was well known that the temperature coefficient

principal surfaces have great influence upon the temperature coefficient, so that we decided to abandon this plate, because of difficulties in manufacture.

In 1932, we realized that the characteristics involved in this plate had been much more complicated than expected. From the theory of thickness vibration, the wavelength of the electric wave which corresponds to the frequency of vibration of a plate one millimeter thick (so-called wave constant according to Cady) should necessarily change as shown in Fig. 7, when the orientation of the cutting of the plate is rotated

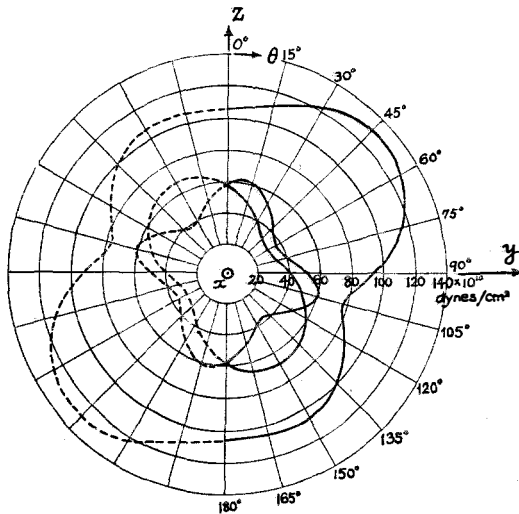

Figure 3—Values of $c's$ in the Frequency Equation (1) when the Normal to a Plate is in the Plane $\phi = -30^\circ$ or 90° .

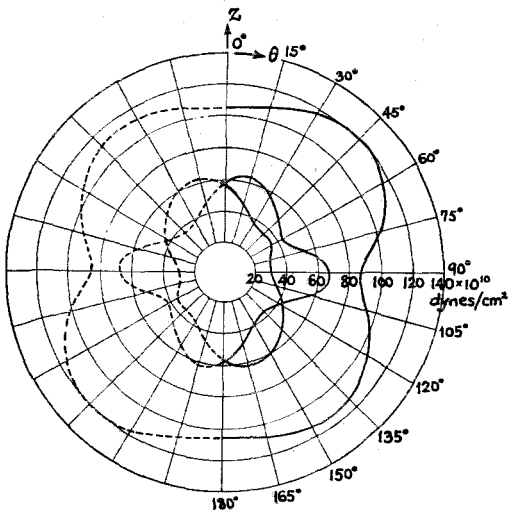

Figure 4—Values of $c's$ in the Frequency Equation (1) when the Normal to a Plate is in the Plane $\phi = -5^\circ, 65^\circ, \text{ or } 115^\circ$.

coefficients of frequency of X-cut and Y-cut quartz plates are negative and positive, respectively, we expected the possibility of getting a zero temperature coefficient plate by cutting quartz in some orientation intermediate between the X-cut and the Y-cut (Fig. 6). Experimentally we succeeded,⁶ but it was found, at the same time, that the form and dimensions of the contour of the

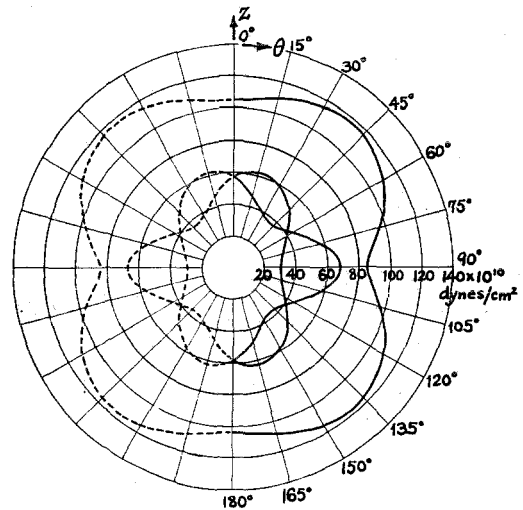

Figure 5—Values of $c's$ in the Frequency Equation (1) when the Normal to a Plate is in the Plane $\phi = 0^\circ, 60^\circ, \text{ or } 120^\circ$.

about the optical axis. (Insert the values of $c's$ for $\theta = 90^\circ$ in Table I into (1).) In this figure the parts of curves shown by full lines mean that we can realize the oscillation easily, while the parts in broken lines mean that the piezoelectric action is not sufficient to realize the oscillation easily.

A glance at this figure reveals at once that the period of vibration which is realizable does not continuously change from X-cut to Y-cut, so that we cannot expect the existence of a zero temperature coefficient plate in the intermediate orientation between X-cut and Y-cut plates from the mere fact that their temperature coefficients are opposite in sign.

In fact, we were aware afterwards that if the

⁶ I. Koga, "Influence of Temperature upon Frequency of Oscillating Quartz Plate," Supplementary Issue, *Jour. I.E.E. (Japan)*, p. 1, April, (1929).

plate is sufficiently thin, we could no longer get the zero temperature coefficient plate, and that the zero temperature coefficient could only be obtained when the thickness of the plate is considerable compared with the dimensions of the principal surfaces. That was also the reason why

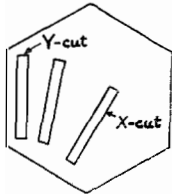

Figure 6—Trial Cutting to Find the Plate of Zero Temperature Coefficient in the Intermediate Orientation Between X- and Y-Cut Plates.

the temperature coefficient was greatly influenced by the form and dimensions of the contour of the plate.

In connection with this fact we observed the characteristics as shown in Fig. 8 by changing the thickness of the plates of given form and dimensions (dimensions of the principal surfaces being always twenty-five by thirty millimeters). These results show that even a Y-cut plate can have zero temperature coefficient if the dimensions are properly selected.⁷

⁷ W. A. Marrison, "A High Precision Standard of Frequency," *Proc. I.R.E.*, vol. 17, p. 1103-1122; July, (1929); *Bell Sys. Tech. Jour.*, vol. 8, p. 493; July, (1929).

As mentioned above we hoped that the orientation of cutting for zero temperature coefficient plates could be definitely fixed in order to simplify manufacture and to guarantee uniformity of characteristics in the finished product.

To meet these requirements, we must use a sufficiently thin plate, for in thin plates all the characteristics are always fixed by the orientation of cutting, and at the same time, the frequency of vibration may be easily adjusted to a desired value merely by varying the thickness of the plate, and this may be done without any deleterious effect on the characteristics.

Now, to get the orientation of a zero temperature coefficient plate, we must search in a region where the frequency of the plate of a given thickness varies continuously with orientation, and avoid such regions as were explored during the first trial already described at the beginning of this chapter.

One of the best ways of doing this is to observe the characteristics of plates which have been cut so that their principal surfaces have various orientations about the *electrical* axis, since in this case

(1) there is only one mode of thickness vibration capable of being maintained in the oscillator circuit, and its frequency of vibration varies continuously with the variation of orientation as explained at the end of the last chapter; moreover

(2) since, as we have already recognized experimentally in 1932, the temperature coefficients of R-cut and R'-cut plates⁸ corresponding to $\theta = 128^\circ 13'$ and $\theta = 51^\circ 47'$ are, respectively, positive and negative, we may expect to find an orientation with zero temperature coefficient.

Experimental results obtained in 1933^{9,10} are shown in Figs. 9 and 10 and Table II. The temperature coefficient of frequency is zero at angles $\theta \approx 55^\circ$ and $\theta \approx 138^\circ$. The detailed observations in the neighborhood of these angles showed that the change of frequency due to temperature is

⁸ I. Koga, Japanese Patent No. 95637, January 15, 1932 and No. 99670, November 16, 1932.

⁹ I. Koga and K. Ichinose, "Piezoelectric Oscillating Quartz Plate of Zero Temperature Coefficient," Supplementary Issue, *Jour. I.E.E. (Japan)*, p. 135, April, (1933).

¹⁰ I. Koga and N. Takagi, "Piezoelectric Quartz Oscillating Plates with Temperature Coefficients less than $10^{-7}/^\circ\text{C}$," *Jour. I.E.E. (Japan)*, vol. 53, no. 10, p. 940; October 10, (1933).

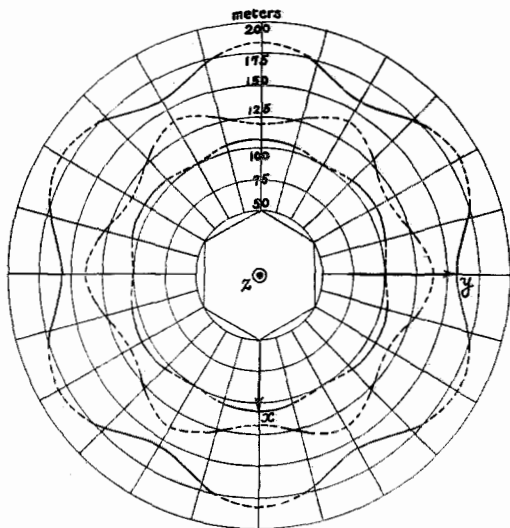

Figure 7—Wave Constants of Quartz Plates Cut Parallel to the Optical Axis. Broken Lines Show the Difficulty in the Realization of Piezoelectric Oscillation.

TABLE II
RELATION BETWEEN THE ORIENTATIONS OF CRYSTAL CUT, AND TEMPERATURE COEFFICIENT OF FREQUENCY

0	Thickness	Frequency	Temperature Coefficient
Degree	mm	kc	$\times 10^{-5}/^{\circ}\text{C}$
27	0.71	2715	-10.0
32	0.47	3978	-9.0
45	0.63	2709	-4.8
52	0.62	2690	-1.8
64	0.56	2981	+4.8
73	0.57	2980	+7.6
80	0.65	2691	+9.8
90	0.73	2688	+10.3
100	0.71	2981	+8.7
110	0.84	2689	+6.3
123	0.90	2700	+3.2
128	0.92	2689	+2.0
133	0.93	2696	+0.9
138	0.94	2690	-0.2
148	0.95	2690	-2.4
153	0.95	2690	-3.4
158	0.94	2690	-4.5
163	0.93	2693	-5.5

Dimensions of principal surfaces: 22 mm \times 27 mm, the shorter sides being parallel to the electrical axis.

TABLE III
TEMPERATURE COEFFICIENTS OF PLATES AT $\theta \sim 55^{\circ}$

	α	θ	Dimensions (mm)	Frequency (kc)
1	2° 51'	54° 38'	0.62 \times 21.3 \times 27.0	2692.4
2	54.5'	41.5'	0.62 \times 23.2 \times 28.5	2689.8
3	56'	43'	0.62 \times 21.1 \times 27.0	2691.0
4	58'	45'	0.62 \times 22.1 \times 27.0	2692.7
5	3° 02.5'	49.5'	0.62 \times 22.0 \times 27.0	2691.4
6	07.5'	54.5'	0.62 \times 22.1 \times 27.1	2692.1
7	16'	55° 03'	0.62 \times 22.0 \times 27.0	2687.7

α =angle measured by means of X-ray spectrometer.

θ = $\alpha+90^{\circ}-38^{\circ}13'$

Shorter sides of the principal surfaces are parallel to the electrical axis.

not linear¹¹⁻¹² but somewhat complicated as shown in Figs. 11 and 12. Numerals given in these figures correspond to those in Tables III and IV. Test pieces were all rectangular plates and their

¹¹ I. Koga et M. Shoyama, "Caractéristiques Fréquence-Température de Plaque de Quartz Oscillant à Coefficient de Température nul," *Comptes Rendus*, tome 200, no. 14, p. 1224; April 1, (1935).

¹² I. Koga and N. Takagi, "Thermal Characteristics of Thin Oscillating Quartz Plates," *Jour. I.E.E. (Japan)*, vol. 54, no. 5, p. 399; May 10, (1934).

¹³ I. Koga and N. Takagi, "Temperature Coefficients of Elastic Constants of Quartz," *Jour. I.E.E. (Japan)*, vol. 53, No. 12, p. 1141; December 10, (1933).

principal surfaces were made parallel to the electrical axis within half a minute by means of an X-ray spectrometer.

We see from these results that if $\theta=54^{\circ}43' \sim 54^{\circ}45'$ the frequency of vibration is practically independent of the temperature at room temperatures.

From the data given above, we further determined¹³ the temperature coefficients of the adiabatic elastic constants ($c_{11}-c_{12}$), c_{44} and c_{14} in (5). Once the temperature coefficients of the adiabatic elastic constants are obtained, we can calculate the temperature coefficient of frequency for any value of θ . The curve in Fig. 10 is drawn from values thus calculated, while the measured values given in Table II are plotted with small circles in the same figure, showing how well they agree.

III. Improvement of Short Wave Wireless Transmitters for Commercial Service by Means of Oscillating Crystals with Zero Temperature Coefficient

X-cut quartz crystals have been generally used in Japan in high-frequency transmitters for commercial service because their temperature coefficients are lower than those of other well known types.

Since X-cut plates do not function satisfactorily at very high frequencies, the frequencies of the plates are generally chosen under 2500 kilocycles (120 meters) and two or three stages of frequency doublers with power amplifiers are employed to attain the desired frequency and power. Moreover, as the X-cut quartz plates on the market have temperature coefficients of about 20 to 30×10^{-6} per degree centigrade they are placed

TABLE IV
TEMPERATURE COEFFICIENTS OF PLATES AT $\theta \sim 138^{\circ}$

	θ	β	Dimensions (mm)	Frequency kc
1	136°06'	7°53'	0.504 \times 25.9 \times 29.9	5014.6
2	137°10'	8°57'	0.541 \times 25.8 \times 29.6	4661.9
3	137°44'	9°31'	0.542 \times 22.2 \times 28.3	4654.6
4	138°13'	10°00'	0.540 \times 25.0 \times 29.7	4678.3
5	138°47'	10°34'	0.542 \times 25.0 \times 29.2	4653.6

β =angle measured by means of X-ray spectrometer.

θ = $\beta+90^{\circ}+38^{\circ}13'$.

Shorter sides of the principal surfaces are parallel to the electrical axis.

in temperature controlled compartments which are generally completely lined with thick metal, so that the stray capacity of the electrodes and wires to the quartz plates increases the equivalent capacity between grid and cathode of the oscil-

lator tube and makes the oscillator unstable. Further, considerable attention is required to maintain the thermostat equipment in working condition. Therefore, to find some means to dispense with the thermostat was highly desirable from a practical point of view.

Early in July of 1933, we tested¹⁴ the short wave plates of small temperature coefficient referred to in the previous chapter, in a high power radio transmitter at Yosami (near Nagoya), the transmitting station of the Japan Wireless Telegraph Company, incorporating, at the same time, certain circuit improvements. Because the results were excellent, the company decided in March, 1934, to incorporate these improvements in all of the transmitters in their stations. This work was completed in August, 1934, and since that time, the thermostat has disappeared entirely.

The principal points gained as a result of these improvements are as follows:

(1) *Frequency of crystal is doubled.* Since the new crystal plates vibrate very easily at very high frequency, the frequency of these crystals is always chosen between 2500 and 6000 kilocycles, making it possible to employ not more than two stages of frequency doublers in order to obtain any frequency for commercial service.

(2) *Oscillator tube is changed.* Triode Type UX-210 has long been used as the crystal oscillator tube. This type of tube was replaced by the pentode Type UY-247 because it can deliver considerably more power to the plate circuit with less power dissipated in the crystal than was the case with the Type UX-210. Moreover the stability of frequency using the pentode was found to be superior to that obtainable with the UX-210. Figs. 13 and 14 show, respectively, the characteristics of the triode and of the pentode oscillator. As is readily seen from Fig. 14, in the pentode oscillator, the frequency variation due to the variation of impedance in the plate circuit (see the effect of R and C), is of the order of one part in 10^5 in the working condition, so that the tube stage next to the crystal oscillator need no longer be treated as a buffer amplifier but may be

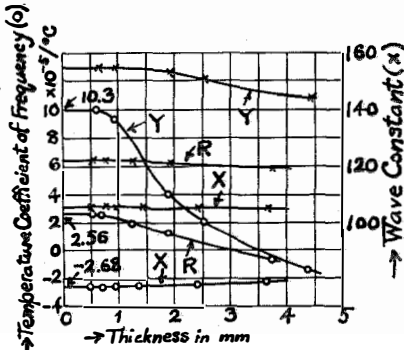

Figure 8—Change of Wave Constant and Temperature Coefficient Due to Thickness.

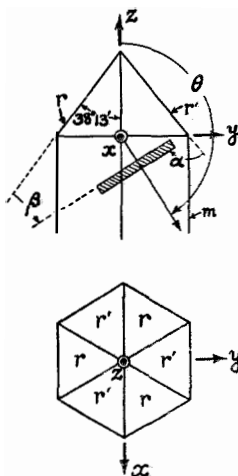

Figure 9—Explanation of the Meanings of θ , α , and β Appearing in Tables II, III, and IV and Figs. 10, 11, and 12.

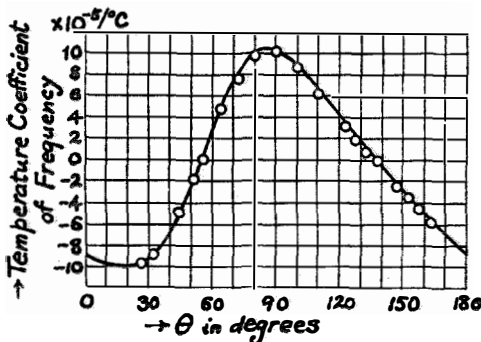

Figure 10—Change of Temperature Coefficient Due to the Change of Cutting Orientation.

¹⁴ I. Koga, M. Nagaya, and T. Kusakari, "Improvement of Short-Wave Commercial Radio Transmitter by the Employment of Oscillating Quartz Plate of very Small Temperature Coefficient of Frequency," *Jour. I.E.E.* (Japan), vol. 53, no. 10, p. 917; October 10, (1933).

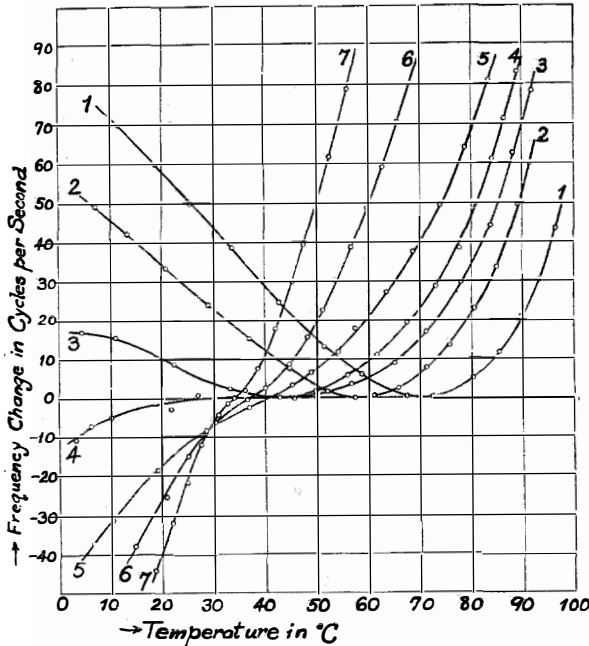

Figure 11—Frequency-Temperature Relation at $\theta \approx 55^\circ$. Numerals Correspond to Those in Table III.

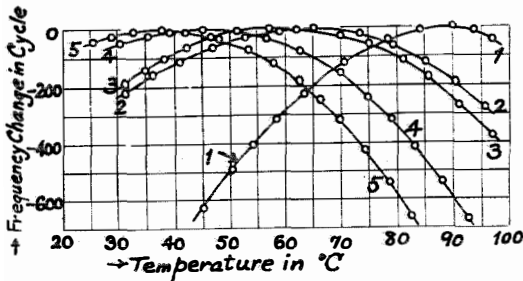

Figure 12—Frequency-Temperature Relation at $\theta \approx 138^\circ$. Numerals Correspond to Those in Table IV.

operated at full power as an ordinary amplifier.

Frequency variation due to about ten per cent change in any one of the following, (a) fluctuation of the plate voltage, (b) grid-bias voltage, (c) resistance of grid leak, and (d) filament terminal voltage, was found to be considerably less than one part in 10^5 . When the quartz plate is transferred together with its holder from one transmitter to another of the same type, the frequency change of the oscillator is also less than one part in 10^5 , so that if we wish to interchange the frequencies of two transmitters, we need only interchange the crystals together with their holders.

(3) One stage employing Type UX-860 tube was omitted. Before the improvements were made,

there were three stages of frequency doublers using Type UX-860 tubes. Since, however, the frequency of the crystal had been doubled and the power output of the crystal oscillator circuit and the next stage to it had been increased, one stage of frequency doubler could be omitted without any reduction of the output in the last stage of the transmitter.

(4) *Crystal oscillator in a transmitter.* A crystal oscillator employing an ordinary crystal plate has to be started some time prior to actual use of the transmitter, because the frequency of the crystal oscillator will gradually change due to the temperature rise caused by the mechanical vibration of the crystal, even though the temperature within the thermostatically controlled compartment is kept constant. Accordingly, two complete oscillators with crystals in operating state were always kept in a transmitter to assure quick change of frequency. But as there is practically no influence of temperature upon the new crystal plate, it is now quite sufficient to provide only one crystal-oscillator circuit. At present three crystals corresponding to three different wave frequencies are provided in each transmitter and any one of them can be connected by means of a dial switch to the oscillator tube.

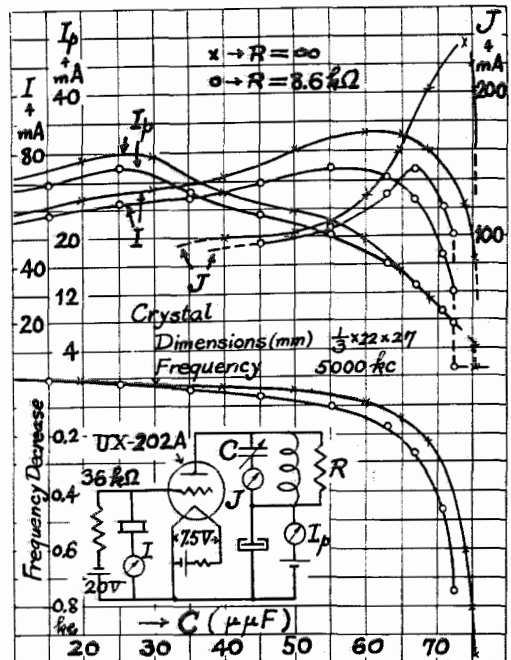

Figure 13—Characteristics of Triode Crystal Oscillator.

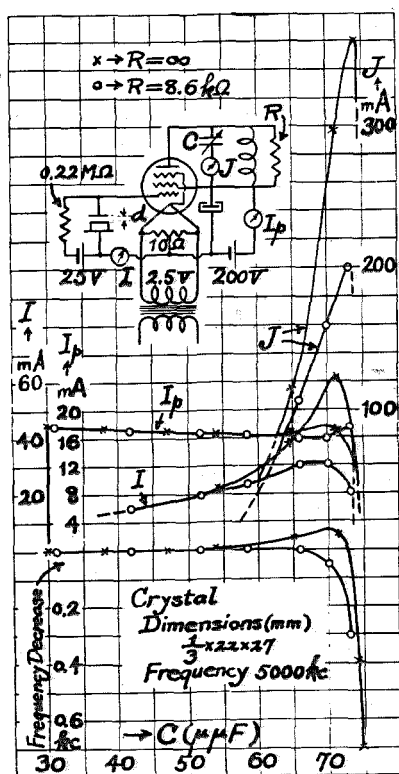

Figure 14—Characteristics of Pentode Crystal Oscillator.

(5) *Crystal holder is specially designed.* Under present operating requirements, it is necessary to adjust the frequency of a transmitter exactly to the assigned frequency. This adjustment is almost impossible if we intend to rely upon fine adjustment by varying the thickness of the plate, since this operation is too delicate for even a very skilled workman. With the older types of crystals, it has been customary to make this final adjustment of frequency by varying the ambient temperature of the crystal. This procedure is obviously not applicable to the new type of crystal.

Since an oscillator with the new type of crystal is very easily maintained in oscillation, it is possible to change its frequency readily even more than one part in 10^3 by varying the air gap between the crystal and one of its electrodes without any reduction in the output power of the oscillator. Fig. 15 shows the dependence of frequency upon air gap d (see also Fig. 14) between the quartz plate and the upper electrode. The details of construction of the holder are shown in Fig. 16. The upper electrode for the crystal can

be finely adjusted and fixed at any position to provide a certain air gap above the crystal plate in order to get exactly the required frequency. To make the electrodes sufficiently parallel, we use a metal spacer of uniform thickness shown in the same figure, and the lower electrode is used only to keep this spacer in place. If this container is used in an inclined position, the quartz plate is held by notches in the spacer, so that a stability of frequency better than one part in 10^5 is still obtained.

After the improvements described above were made, the overall frequency fluctuations of the transmitters from the assigned frequencies always remained within about five parts in 10^5 . As the temperature coefficient of frequency of the crystal is always less than 2×10^{-6} per degree centigrade the frequency variation due to changes in temperature is always within 2.5 parts in 10^5 , since the ambient temperature of the crystal remains between 15 degrees and 40 degrees centigrade throughout the year.

At present, the Ministry of Communications, the International Telephone Company (Kokusai Denwa Kaisha, the sole company for international radiotelephone service in Japan) and the Broadcasting Corporation of Japan are preparing to employ the new type of quartz plates. In short, Japanese stations are all about to make the same improvements.

Recently, we had an opportunity to test the new type of crystal in the transmitter used for

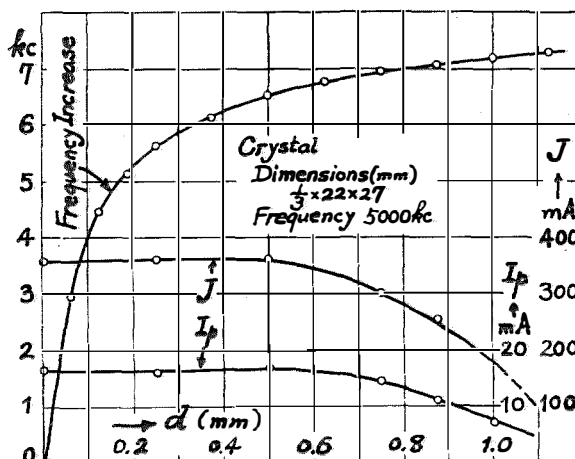

Figure 15—Influence of Air Gap Between Crystal Plate and Electrode upon the Frequency and Amplitude of Oscillation.

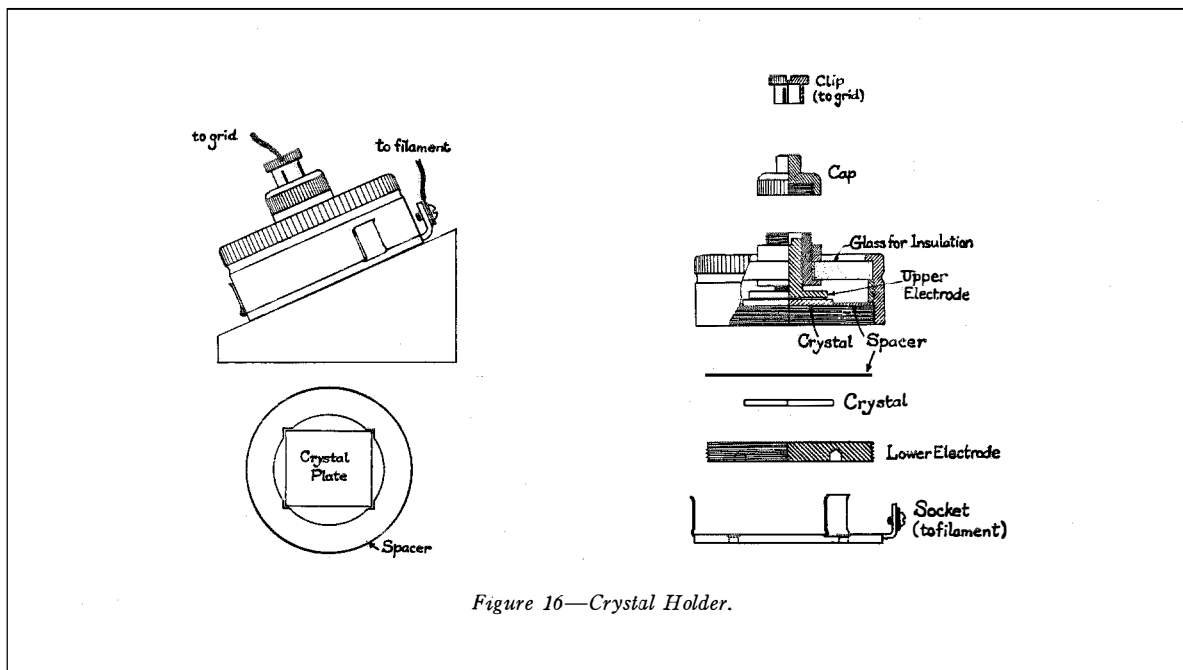

Figure 16—Crystal Holder.

the ship-to-shore radiotelephone service provided by the International Marine Radio Company, Limited, on the "Berengaria" of the Cunard Line, through arrangements made by H. H. Buttner, vice president of the Mackay Radio and Telegraph Company. The radio operator on the "Berengaria" stated "the Oceangate, N. J., frequency checking station reported the carrier stability good and comparing favorably with the thermostatically controlled crystals in general use . . . the frequency of the crystal was 4412.82 kilocycles at 20 degrees centigrade and 4412.875 kilocycles at 50 degrees centigrade. The variation is thus only 0.055 kilocycle for a change in temperature of 30 degrees centigrade."

IV. Crystal Oscillators of Special Connections

Although usually a single crystal plate is used for stabilizing frequency, two or more crystals may also be used in one circuit. Such circuits with several crystals have some interesting properties. We will discuss two examples of such circuits.

Consider the Pierce oscillator: In this circuit, the change of frequency due to a change in the plate circuit is not as serious as a change in the

grid circuit. Suppose that we wish to eliminate even this minor effect, the following method will be found one of the best:

As the oscillating crystal equipped with its electrodes can be considered to be an electrical circuit, we see that the necessary impedance in the plate circuit can also be obtained by a crystal plate of proper dimensions. Thus we can replace the plate circuit by another crystal circuit as shown in Fig. 17. As the crystal circuit blocks direct current, anode current is supplied through a resistance or a choke coil D . If the air gap between an electrode and the crystal Q is made adjustable, oscillation starts very easily even if the dimension of P is not so precisely adjusted. Fig. 18 shows the change of frequency and anode current due to variation in air gap (in microns) between crystal P and one of its electrodes. From this figure, we see that variation in frequency, due to a slight change in the air gap with time, would be negligible

Incidentally, it may be added that variation of frequency due to the variation of grid-leak resistance from 0.03 to 0.1 megohm, plate circuit resistance D from 0.01 to 0.02 megohm, filament terminal voltage from 4.5 to 5.5 volts, anode voltage from 100 to 70 volts, was observed to be about 30 cycles, 4 cycles, 1 cycle, 0.5 cycle,

respectively, at the oscillating frequency of 2691 kilocycles.

The most interesting feature of this oscillator is that neither inductance nor condenser is used, so that there is practically no danger of frequency variation due to stray induction

It goes without saying that this idea is also applicable to many other types of oscillators.

Another example of a special oscillator. If two crystals *A* and *B* of the same frequency be connected in parallel or in series (two crystals may be placed one upon the other) as shown in Figs. 19 and 20, the frequency of oscillation is, of

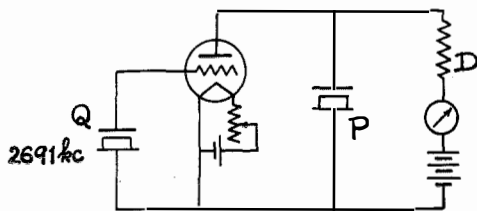

Figure 17—Crystal Oscillator in which the Plate Circuit is Replaced by Another Crystal.

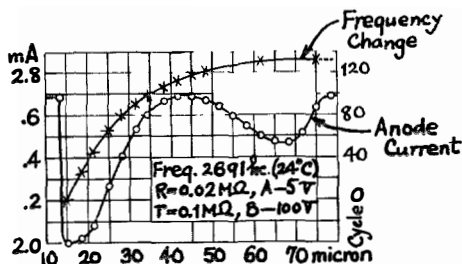

Figure 18—Change of Frequency and Plate Current Due to the Change in Air Gap for Crystal *P* in Fig. 17.

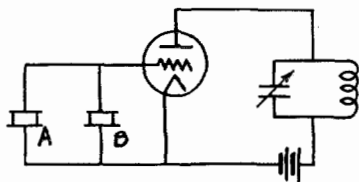

Figure 19—Two Crystals of Nearly the Same Frequency Connected in Parallel.

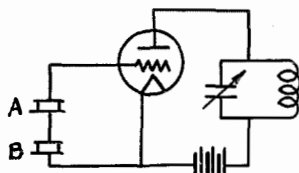

Figure 20—Two Crystals of Nearly the Same Frequency Connected in Series.

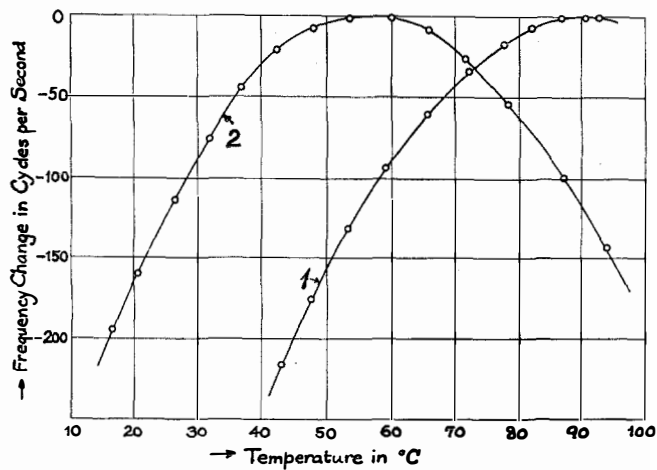

Figure 21—Frequency-Temperature Curve for the Oscillator Shown in Figure 20.

course, nearly equal to that when only *A* or *B* is used. But even if the ambient temperature of the crystals be varied over a very wide range, as long as the oscillation is maintained the frequency is always intermediate between the values obtained with *A* and *B* used individually.

This phenomenon can be explained as follows: In general, when oscillation is maintained in the oscillator, we may consider that the impedances of the several parts are of such values as are necessary to satisfy the condition of oscillation. Now, if the ambient temperature be varied, the impedance for the original frequency in the crystal circuit will change, so that the frequency must also change to recover the original value of impedance (both in magnitude and phase angle, but especially in the latter, because the change in the former is not considerable). In this case, the necessary change of frequency is generally very small, because a very slight change of frequency is generally quite sufficient to change the impedance of the crystal. Practically, we may neglect the change of impedance in other parts of the oscillator due to such a slight change of frequency, thus we can simplify the treatment.

For the sake of convenience, let us suppose that the impedances of the two crystals connected in series be changed slightly to some different values Z_A and Z_B , respectively, from a certain common value, the phase angle of the resultant impedance for the original frequency is surely intermediate between Z_A and Z_B . Therefore, the necessary frequency change to recover

this change of phase angle is of a certain intermediate value between the changes of frequencies necessary in the case when the crystals *A* and *B* are used alone. It is needless to repeat the explanation when two crystals are in parallel.

The most interesting application of this connection is the compensation of temperature effect upon the oscillating frequency by connecting (in series or in parallel) two crystal plates of opposite temperature coefficients. For example, two plates of about 4860 kilocycles were placed one upon the other in a holder. The temperature coefficients of the frequency when the plates were used individually were about -38 cycles/ $^{\circ}\text{C}$ ($-7.8 \times 10^{-6}/^{\circ}\text{C}$) and about $+42$ cycles/ $^{\circ}\text{C}$ ($+8.7 \times 10^{-6}/^{\circ}\text{C}$). Curve 1 in Fig. 21 shows the result when the two plates are placed one upon the other. If we slightly decrease the thickness of the plate of positive temperature coefficient, the maximum point of the curve moves to the left as shown by curve 2 in the same figure. The flat part of the curve near the maximum point shows

that the maximum deviation of frequency due to the change of temperature from about 36 to 77 degrees centigrade is only fifty cycles, which corresponds to a variation of less than $10^{-6}/^{\circ}\text{C}$. Therefore, if we adjust the thickness of both crystal plates so that the oscillating frequency becomes maximum at a required frequency and mean operating temperature, the result will be as striking as that with a plate of temperature coefficient less than $10^{-6}/^{\circ}\text{C}$.

As we have already described in the second section, we cannot get a crystal plate of absolutely invariable frequency over a very wide range of temperature, because the change of frequency due to temperature variation is not always exactly linear. Since it appears, from the above results, that the frequency temperature characteristics of a crystal oscillator can be greatly improved by the employment of two crystal plates in the circuit, we are continuing our experiments.

Micro-Ray Communication*

By W. L. McPHERSON, B.Sc. (Eng.), A.M.I.E.E., and E. H. ULLRICH, M.A., A.M.I.E.E.

Part I. Historical

IN COMMON with the majority of recent scientific developments, micro-ray communication is founded on the work of many isolated individuals. Of these, the foremost was Hertz, all of whose classic experiments in wireless in 1887 were performed with centimetre waves. For various reasons the development of the art gradually drifted away to the longer waves, and it was not until after the War that research again turned to the very short waves. It was discovered by Barkhausen and Kurz in 1919 that centimetre waves could be generated by valves with highly positive grids. This discovery was followed up in many countries and, in March, 1931, the first public demonstration of modern micro-ray telephone communication was given across the Straits of Dover, using 18 cm. waves.¹ Subsequently a permanent link was installed between Lympne and St. Inglevert, using essentially the same principles and wavelength as in the Dover demonstration, but covering a distance of 56 km.

Part II. Micro-Ray Generators and Receivers

The transmitter carrier frequency is generated by means of a triode with positive grid.

Fig. 1[†] shows a micro-ray tube (the word "tube" is used deliberately instead of "valve"). It is a triode but differs from conventional valves as regards its grid, which is a wire helix, both ends of which are brought out. The plate, also symmetrical with regard to grid and filament, is a molybdenum cylinder. The two grid leadouts are connected to a transmission line to which the load is applied. In the concrete case of a valve oscillating at 17.4 cm. the length of the wire grid is 19 cm., i.e., more than one wavelength. The grid may therefore no longer be

* Abstract of a paper read before The Institution of Electrical Engineers, London, January 30, 1936; published by courtesy of The Institution.

† The numbering of the illustrations referred to in this abstract corresponds to that of the original paper.

¹ "Micro-Ray Radio," *Electrical Communication*, July, 1931.

regarded as an electrode but rather as a transmission line which, as it maintains oscillations in the exterior transmission line connected to it, must have negative leakance. It is suggested that the explanation of this negative leakance² lies in the compression and rarefaction of the electron stream at the grid caused by variation in the time of flight of the electron according to the phase of a-c. grid voltage at the moment that the electron leaves the filament. If the voltages are properly chosen, the a-c. component of the electron current at the grid will be in phase opposition to the grid voltage.

It is found by experiment that the same frequency can be generated for different grid and plate voltages (Fig. 2). A large portion of the grid-plate voltage curve for constant frequency is a straight line; it is easy, therefore, by means of potentiometers, to apply from a common source voltages to both grid and plate so that the frequency remains constant, the output intensity curve plotted against either grid or plate volts for constant frequency being a straight line. By this means it is possible to modulate the outgoing carrier in amplitude without at the same time modulating it in frequency. The micro-ray receiving tube is of the same type as the transmitting tube, but the electrode spacing is different. From a high frequency standpoint it is used in the same type of circuit as the transmitter tube. The incoming waves traverse a transmission line to the helical grid and are there detected. In order to explain detection we need only show that the high frequency current at any point of the grid bears a non-linear relation to the high frequency voltage at that point. If the voltages are so adjusted that electrons leaving the filament just fail to reach the plate, the appearance of a high frequency voltage on the grid will cause some of these electrons to reach the plate, since some of the electrons will absorb energy from the grid high frequency and thus succeed in reaching the

² "Production and Utilization of Micro-Rays," by A. G. Clavier, *Electrical Communication*, July, 1933.

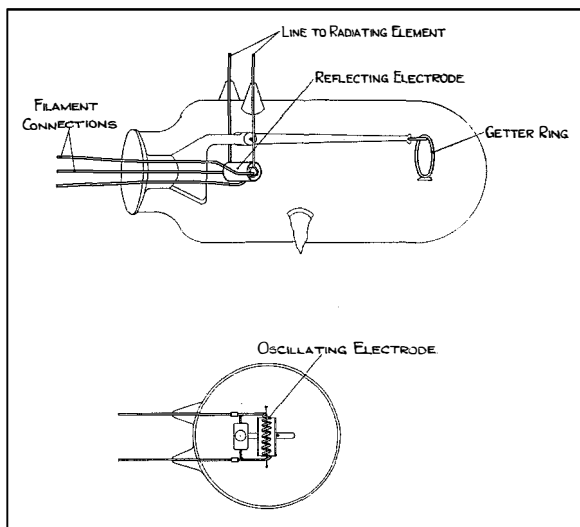

Figure 1.

plate. The high frequency plate current, being a non-linear function of the high frequency grid voltage, contains the detected audio frequency component; and, since the sum of the grid and plate currents is constant, the filament being in voltage saturation, an equal and opposite audio component exists in the grid circuit.

Part III. Aerial Systems

The aerial system for micro-ray communication may follow the lines of ordinary wireless practice. At these short wavelengths, however, we are able to make use of the usual optical devices such as lenses, zone plates, mirrors, and gratings. Micro-rays can quite well be focused by means of lenses even when made of opaque dielectrics such as ebonite. In one particular case a double convex ebonite lens about 2 feet in diameter and about 5 inches thick at the centre brought a micro-ray source about 6 metres in front of it to a focus 40 cm. behind it. The concentration represented a gain of about ten decibels.

The zone plate is another optical device for focusing rays (Fig. 5b). A zone plate consists simply of a number of concentric metal rings of suitable inner and outer radii. When radiation from T (Fig. 5a), reaches the obstacle ABCD, the intensity at any point R may be determined by forgetting the original source T and consider-

ing each point on the plane ABCD as the source of a secondary disturbance, with amplitude and phase dependent on its distance from T. These secondary disturbances radiate to all points on the right of plane ABCD.

Set $TBR - TAR = \lambda/2$ and $TCR - TBR = \lambda/2$, etc. The intensity at R, due to the secondary source at B, will be out of phase with the intensity at R, due to the secondary source at A. Similarly, at any point source between B and C there corresponds a point source between A and B whose intensity at R is 180° out of phase. Alternate zones AB and BC, therefore, tend to destroy one another. If we let all the radiation from T reach R, i.e., if we remove the obstacle ABCD, we obtain a certain intensity at R. If, however, we block out the rays reaching zones BC and DE, etc., the influence of which is destructive at R, we increase the intensity at R, i.e., we bring the rays to a focus there. The zone plate shown in the slide gave a measured gain of 8.6 db.

The paraboloidal mirror with micro-ray source at the focus, however, gives greater gain than either lenses or zone plates. As it is usually convenient to have equipment of this kind made in the factory rather than on site, its size is limited by transport and other practical considerations. The problem then, as it presents itself to the engi-

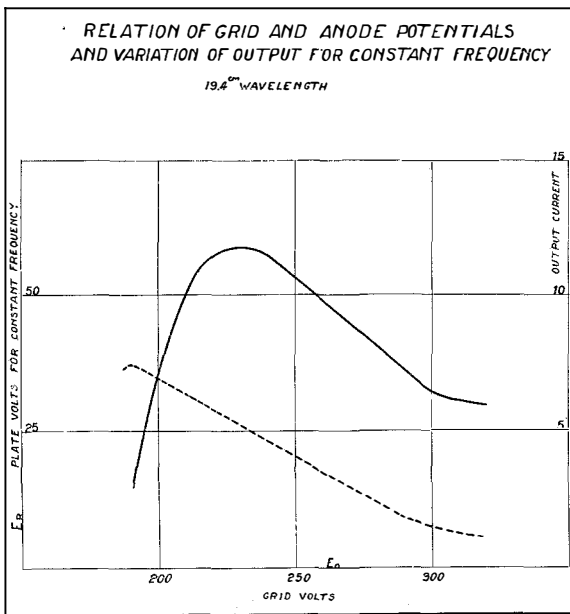

Figure 2.

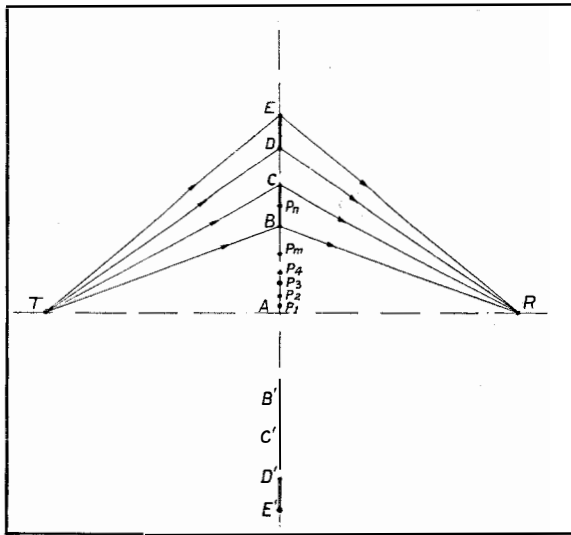

Figure 5a.

near, is to design such a mirror so as to obtain the greatest gain for a given aperture.

A moment's consideration will show that every point on the mirror surface is not energized equally by a micro-ray doublet at the focus, as the doublet itself has a distinct radiation diagram. For example, points in line with the doublet are not excited at all.

Considerations given in the paper show that actually destructive areas occur, i.e., areas whose contribution to the signal at a distance is out of phase with the main signal. Fig. 9 shows the destructive areas projected on to the director plane. If the focal plane lies in the aperture, these destructive areas disappear and it is, therefore, not surprising that calculation shows that the gain is then a maximum and equal to the number of wavelengths in half the aperture circumference. In the case of the Lympne reflectors this gain was 28 db., which was increased to 31 db. by the use of a hemispherical mirror in front of the doublet.

In order to obtain correct phasing the diameter of the spherical mirror must be a multiple of half a wavelength and not an odd multiple of a quarter wavelength as might be expected. This is due to the curious Gouy effect, whereby the phase of rays is accelerated 180° at passage through a focus.

Part IV. Equipment

The equipment of a micro-ray station can be

grouped into the following main divisions:

- (a) Aerial and reflector system for transmission.
- (b) Aerial and reflector system for reception.
- (c) Generating circuits for transmission.
- (d) Detecting circuits for reception.
- (e) Control equipment.
- (f) Power supplies.

Items (a) and (c) above are necessarily located close together, as are also (b) and (d), since it is inadvisable to have very long connections (long as measured by the number of wavelengths) between the micro-ray tube and its associated radiating or receiving aerial. This holds good for all micro-ray tube circuits, and for all aerial and reflection systems of whatever type. The location of items (e) and (f) is, however, governed by convenience and cost, rather than by purely electrical considerations, and may be at a considerable distance from other parts of the system. The practical points involved are well illustrated in the installation of the Lympne-St. Inglevert link, which not only uses the shortest wavelength of any commercial station in the world—17.4 cm.—but also constitutes the longest micro-ray circuit in regular operation up to the present time.

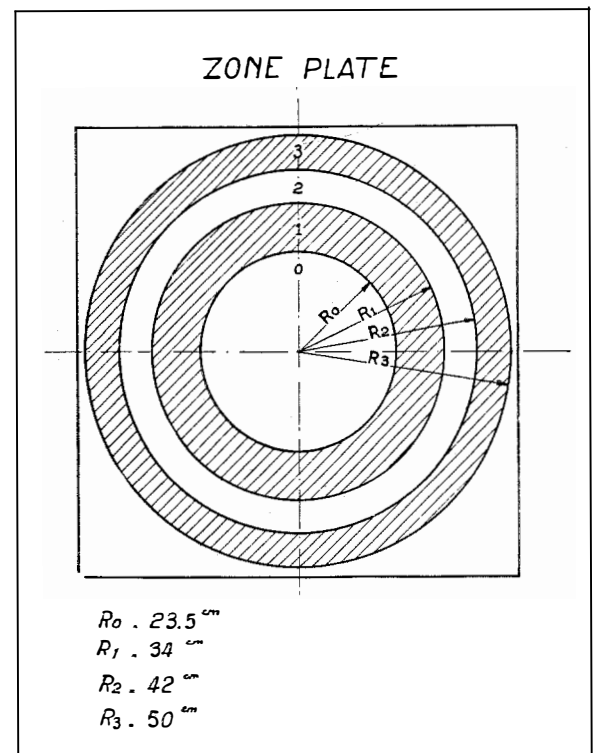

Figure 5b

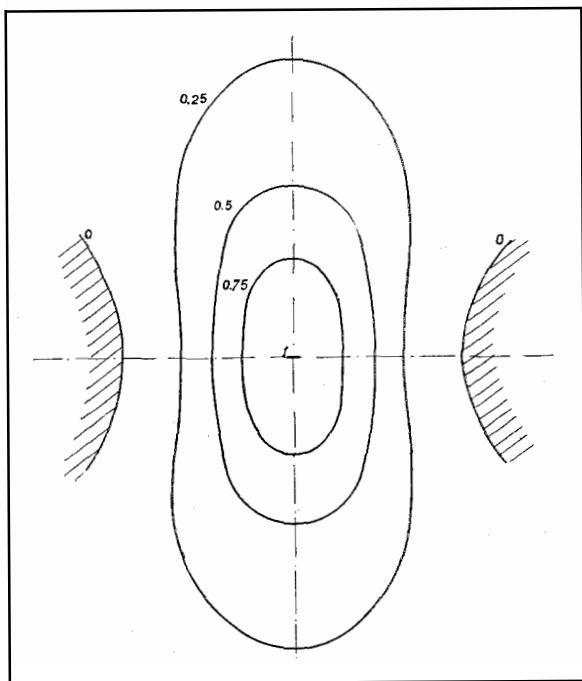

Figure 9.

As regards the purely micro-ray side of the equipment, the aerial and reflector assemblies at both ends of the link are similar in construction and are based on the optical reflector principle instead of the orthodox aerial array. The aerial is of the half-wave dipole pattern, located at the focus and in the aperture of a paraboloidal aluminium mirror reflector some 10 feet in aperture diameter, spun from aluminium sheet approximately 0.2 inch thick. A special advantage of the optical system of reflectors, as compared with the array, is that the plane of polarisation of the beam is uniquely determined by the plane of the dipole element, which can easily be rotated. Accordingly, on the Lympne-St. Inglevert link, the two channels are operated on different planes of polarisation, thereby still further reducing the possibility of crosstalk. The Lympne-St. Inglevert channel is operated with a horizontally polarised wave, the other channel being operated with a vertically polarised wave, and the transmitter and receiver aerial doublets are placed horizontally and vertically, respectively, at the Lympne end of the link. There is no particular merit in this selection of planes of polarisation; any two planes at right angles would give the same benefits.

A general description³ of the main features of the two stations is given. The details of the amplifier and power gear call for no special comment, except that provision is made for rather fine adjustment of the micro-ray operating voltages, and also that plate and grid voltages, derived from metal rectifiers, are stabilised by means of small capacity floating batteries. Simplified schematics of the micro-ray portions of the transmitter and receiver are shown in Fig. 13 and Fig. 14, respectively.

Part V. Propagation

Propagation measurements covered the two links, St. Margarets-Escalles and Lympne-St. Inglevert, over a discontinuance period from February, 1931 to July, 1935. As a general conclusion, it may be stated that the signal is steady during the winter months but subject to large variations during the summer. A fall of 40 db. in the output audio signal has been encountered. In the case of both links there is an unobstructed optical path between terminal stations and, in the case of the St. Margarets-

³ "The Anglo-French Micro-Ray Link between Lympne and St. Inglevert," by A. G. Clavier and L. C. Gallant, *Electrical Communication*, January, 1934.

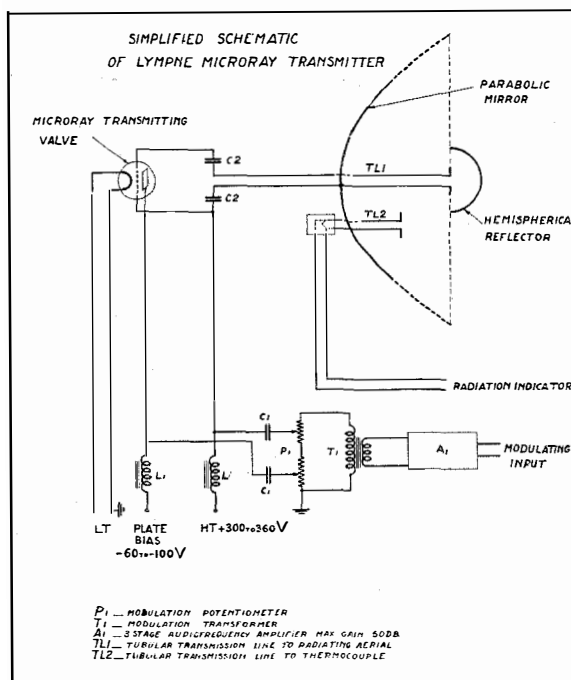

Figure 13

curves show stable conditions, stable conditions will necessarily prevail.

The general conclusion to be drawn is that the primary condition for good micro-ray working is a thoroughly well-mixed and homogeneous atmosphere, free from "pockets." In the summer, currents of hot air probably create "pockets" of very different refractive power from the rest of the atmosphere and the direction of transmission may be violently changed and/or unusual attenuation introduced. In summer the passage of a cloud across the sun's rays will give a temperature kick of magnitude different above the land from what it is above the sea, owing to the difference in reradiation from land and sea. We may, then, consider the transmission path as being through a compound lens of at least three elements of different densities. Add an air "pocket" and the problem becomes one of a compound lens with a bubble in it.

If we admit that there is a reflected ray, clearly its path will be subject to the same type of perturbation, but possibly not at the same time or of the same magnitude as for the direct ray. This makes the problem exceedingly complex.

The results of experience with the two links described may be summarised as follows:

- (1) The most stable micro-ray conditions coincide with very stable atmospheric conditions as judged by thermometer and barometer.
- (2) Given stability of temperature and pressure, the actual values seem to have no importance.
- (3) Given stable temperature and pressure: rain, hail, snow, or fog, do not affect the link.
- (4) No definite relation between the electrical state of the atmosphere (potential gradient) and micro-ray stability has been found. Excellent operation has been obtained during thundery periods, but there is no information as to the general atmospheric stability at the time.
- (5) A high wind is almost invariably accompanied by good micro-ray transmission.
- (6) Sudden changes in temperature are usually accompanied by micro-ray fading; likewise sudden barometric changes. Rapid fluctuations in temperature occur much more frequently on hot days than on cold days; fading is much more pronounced during the summer months than in winter.
- (7) The settling of a heavy bank of fog has been accompanied by very severe and rapid fading, followed by stability when the fog bank has ceased to move.
- (8) During the summer, extremely violent fades of

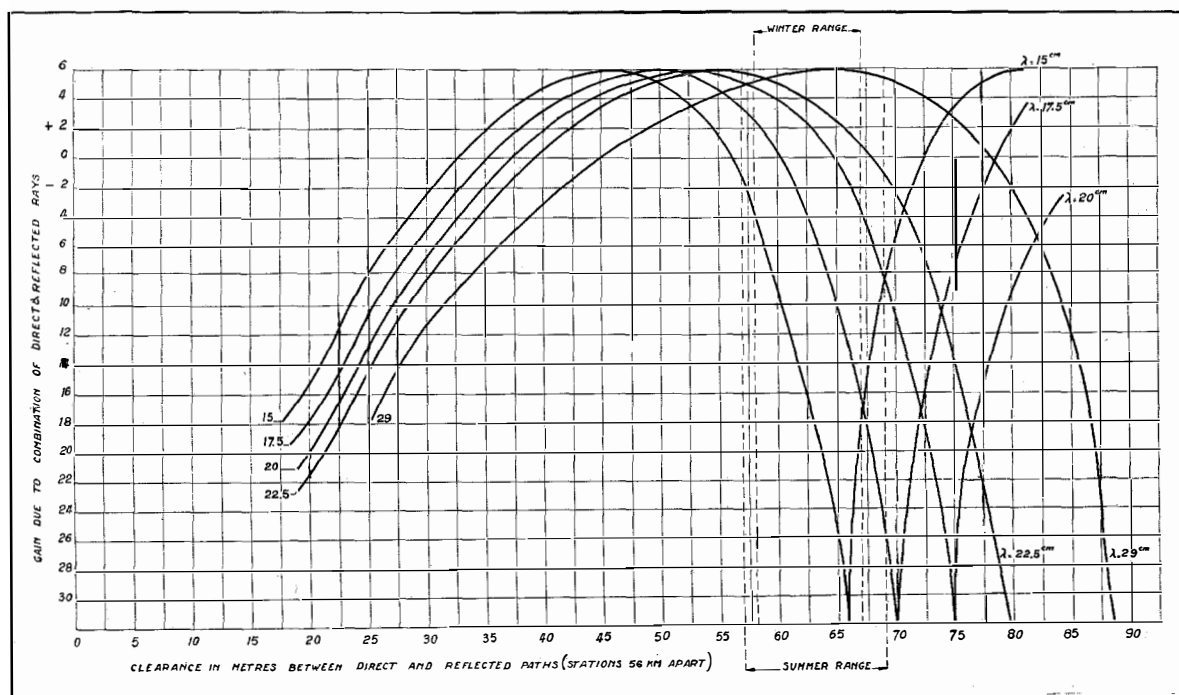

Figure 18.

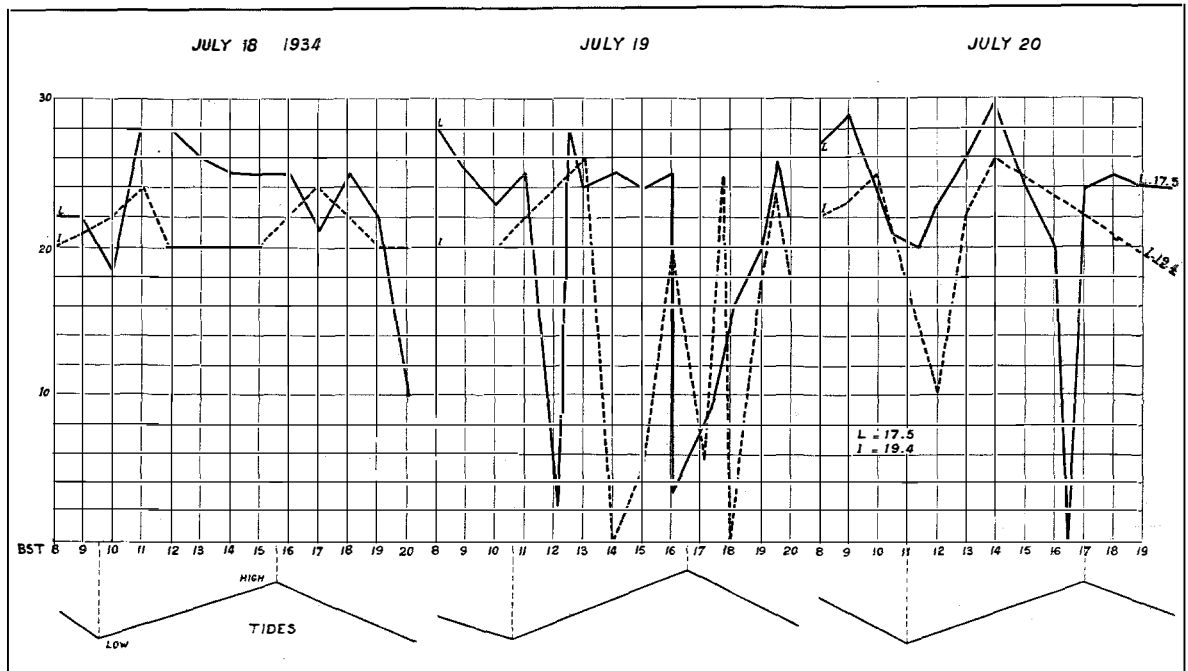

Figure 19.

very short duration—1 to 2 minutes—have been noticed.

- (9) During the summer, fading at audio frequency seems to occur both in broad daylight and in darkness.
- (10) Ultra-short waves of 6 metres length are much stabler than micro-rays over optical paths across the Straits of Dover.
- (11) In noisy locations micro-rays have the advantage over ultra-short waves of being much less affected by "man-made static."
- (12) Micro-ray communication is much more private than ultra-short waves.

Part VI. General

In this section a short survey of the possible field of exploitation is given. The factors affecting the situation may be summarised as follows:

Micro-ray covers an as yet unoccupied portion of the available frequency spectrum, and gives us the possibility of operating large numbers of short range stations without interfering with existing services. It lends itself to extremely sharp directivity, which might be of special value in military communications. Wide-band modulation is another feature of importance. On the other hand, the existence of fading due to interference by reflected rays, the apparent readiness with which such reflection may be set up, and the variability introduced by atmospheric fluctuations, all combine to introduce limitations which require much more research before the field of exploitation can be really determined.

Proceedings
of the
International Telephone Consultative Committee
(C.C.I.F.),
Budapest, September 3-10, 1934

English Edition

IN LINE with previous practice* the International Standard Electric Corporation has published an English translation of the Proceedings of the Xth Plenary Meeting of the C.C.I.F., held at Budapest, September 3-10, 1934.

The official French text is contained in five separate volumes with an additional general subject index volume, comprising in all 1200 pages.

- Vol. I Procès-verbaux of Plenary Sessions.
Lists of Questions under study.
General information and Bibliography.
- Vol. II Protection against high-tension interference and corrosion.
- Vol. III Transmission. Definitions, Recommendations, and Specifications.
- Vol. IV Transmission. Standards. Methods and Apparatus of Measurement. Maintenance.

Vol. V Organization, Operating and Telephone Rates.

The English translation, which has been prepared by the Technical Staff of the International Standard Electric Corporation, is contained in one volume of 650 large quarto pages, uniform in format with previous volumes.

The English edition is limited in number and, experience having shown that the demand for copies is very great, it is again necessary to make a nominal charge for this volume to cover the cost of production.

Requests for copies should be addressed to the Corporation's offices either at Connaught House, Aldwych, London, W.C.2., England or 67 Broad Street, New York City.

* "Proceedings of the International Consultative Committee on Long Distance Telephony," *Electrical Communication*, Oct., 1932 and July, 1933.

Recent Telecommunication Developments of Interest

IN MOST modern automatic P.B.X.'s. local calls and outgoing calls to the city are handled automatically by the calling subscriber, whereas incoming city calls are directed to an attendant who extends the connection to the wanted local party.

The Bell Telephone Manufacturing Company, Antwerp, has recently completed the development of a new cordless attendant's set, using a key set instead of a dial for selecting the local P.A.B.X. stations. The main purpose of the new design is to increase the efficiency of the operator and this has been attained by applying the following principles:

- (a) Minimum number of manipulations;
- (b) Improved supervision: use of two lamps per junction instead of one, and substitution of visual signals for audible tones;
- (c) Incorporation of a series of new time-saving features, such as parking of busy calls, splitting of trunk connections, and continuous hunting on night switching lines.

The new attendant's set is furnished in two sizes, one for ten and one for twenty trunks. The dial is, of course, retained for calls to the city originated by the operator. One key set, comprising ten keys numbered 1 to 0, is provided.

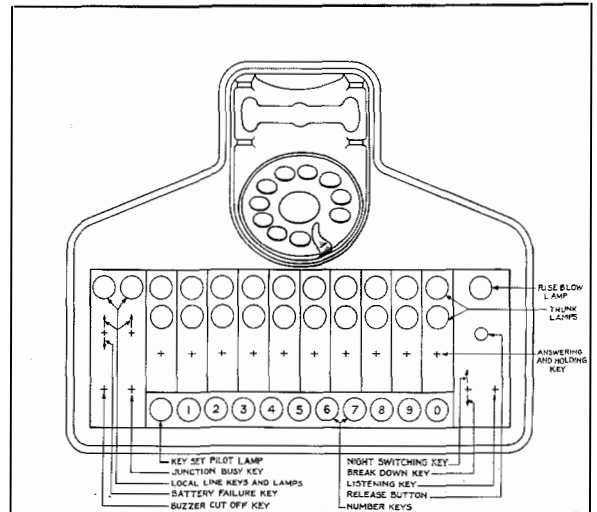

Attendant's Set.

Due to improvements in constructional design, the new attendant's set is cheaper than the existing cordless set, notwithstanding the more elaborate equipment of the former. The new trunk circuit, however, is slightly more expensive than the old one. The combined cost of the new equipment is about equal to that of the existing equipment, although important new facilities have been added.

THE large number of repeaters now in use on international circuits has made it necessary to consider the question of permissible gain change due to changes in the operating battery voltages.

The determination of the permissible change in voltage depends to some extent on whether the variation is likely to be random or to follow some definite cycle, and also on the extent to which valves may deteriorate in performance characteristics prior to being discarded.

It has been considered that a constancy of $\pm 1\%$ in both filament and anode voltages will ensure an adequate stability of gain and at the same time be commercially attainable.

For the purpose of regulating battery voltages, a range of carbon pile regulators has been devel-

oped. These regulators are intended to work between the battery and the load.

General Principles of the Carbon Pile Regulator

The regulators may be divided into two general types:

- (a) Those having directly operated magnet systems;
- (b) Those working on a system of pilot operation.

A directly operated regulator consists essentially of:

- (a) A carbon pile;
- (b) A spring to hold the pile in initial compression;
- (c) A magnet system mechanically connected to the pile and arranged to relieve this compression as required;
- (d) A dash pot to prevent hunting of the regulator.

The carbon pile consists of a stack of annular carbon elements arranged to give the maximum possible resistance range and safely rated as regards maximum operating temperature. It is well known that such a stack of carbon elements gives wide changes in electrical resistance when changes are made in the force compressing the stack.

The carbon stack must generally be connected into the circuit so that an increase in current in the magnet winding causes an increase in resistance, i.e., a reduction of pressure on the stack. Since this requirement calls for the stack to be initially compressed, a helical tension spring is provided for the purpose. This spring also balances all the forces existing in the regulator under operating conditions.

The magnet system of each directly operated regulator consists of a specially shaped armature rotating between two pole pieces and designed so that, in conjunction with the spring, all the forces are balanced at any point in the operating stroke of the regulator provided a given excitation is maintained. Any variation from this predetermined excitation immediately produces a movement of the rotor which, since it is mechanically coupled to the carbon pile, changes the resistance. The movement of the rotor continues until the resistance has been adjusted to restore the excitation to the magnet system to the value required.

With this balanced rotor and spring system, it will be realized that the regulator, which is arranged in the circuit to control both the load and its own excitation voltage, always moves if the load voltage is other than that required for stability, and the regulating function is entirely independent of the characteristics of the carbon pile, provided always that the proper resistance is obtainable within the range of the pile.

An air dash pot is provided in order to prevent the regulator hunting.

Where very large currents have to be controlled, the inertia and friction of the necessarily larger carbon piles tend to decrease the sensitivity of the regulator. It is then desirable to use a small pilot regulator to control the main regulator carrying the full load current. In this case the pilot regulator is made to control the exciting winding of the main regulator and the carbon

pile can be made very light, thus maintaining sensitivity.

With regulators for 24 volt circuits, the minimum voltage drop is about 1 volt, and the range

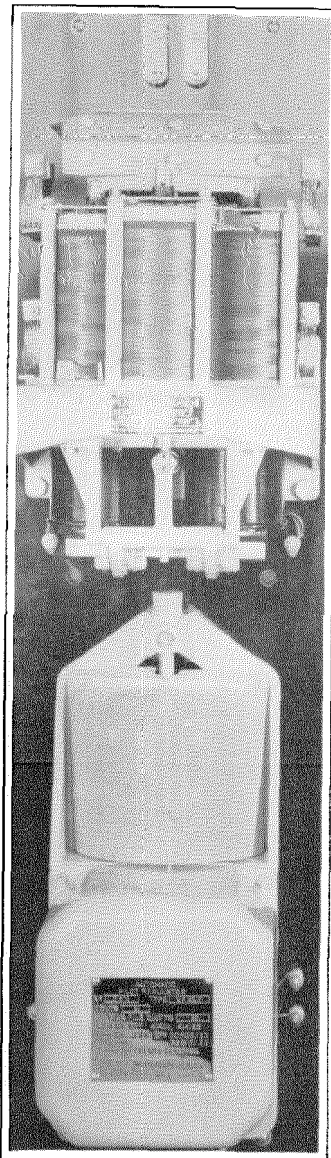

Automatic Carbon Pile Regulator

of resistance obtainable is about 16:1. With regulators controlling 130 volt supply, the minimum voltage drop is of the order of 4 or 5 volts, and the resistance range is about 30:1.

The accompanying illustration shows a 24 volt 75 ampere pilot operated regulator. The two regulators are mounted one above the other, the

pilot being underneath with its mechanism enclosed. The main regulator is completely open. The magnet system, which consists of an ordinary clapper type mechanism, controls three stacks of carbon rings.

There are available 24 volt regulators capable of dissipating from 125 to 750 watts; also 130 volt regulators capable of dissipating from 75 to 500

watts. In either case, alternative regulators can be obtained for giving either 1% or 2% voltage limits.

Regulators of this type can be used for controlling the floating voltage of batteries when operating from rectifiers or from generators. In the latter case, they are connected to control the excitation current of the generator.

THE Personal Call Key Sender, which is a recent development of the Bell Telephone Manufacturing Company, Antwerp, is a time saving device destined for use on the P.A.B.X. extensions of executives who desire to avoid the trouble of consulting a directory or dialing a three or four digit number.

In most organizations it will be found that an executive regularly calls only a selected number of persons. The Personal Call Key Sender permits fourteen different stations to be called by name, instead of by number, by simply depressing a button. The arrangement comprises a key box and an individual circuit and switch for each station given this service. The key box, which is normally placed on the desk near the double line

telephone set, is equipped with fourteen non-locking push buttons, each designated by name. The bell of the called station, if free, rings the instant the button is depressed; otherwise, the busy tone is obtained. There is no waiting for selection.

Only two additional wires are required between the key sender station and the P.A.B.X. Each individual circuit unit is connected to its own group of fourteen selected stations by means of jumpers between the arc of the circuit unit switch and the terminal strips of the P.A.B.X. This enables the key sender to be installed at any station and to be connected to any type of P.A.B.X. with practically no changes in the internal wiring.



Personal Call Key Sender.

Licensee Companies

BELL TELEPHONE MANUFACTURING COMPANY.....	<i>Antwerp, Belgium</i>
<i>Branches: Brussels.</i>	
BELL TELEPHONE MANUFACTURING COMPANY.....	<i>Berne, Switzerland</i>
BELL TELEPHONE MANUFACTURING COMPANY.....	<i>The Hague, Holland</i>
CHINA ELECTRIC COMPANY, LIMITED.....	<i>Shanghai, China</i>
<i>Branches: Canton, Hankow, Hongkong, Peiping, Tientsin.</i>	
COMPAÑÍA RADIO AEREA MARITIMA ESPAÑOLA.....	<i>Madrid, Spain</i>
COMPAÑÍA STANDARD ELECTRIC ARGENTINA.....	<i>Buenos Aires, Argentina</i>
CREED AND COMPANY, LIMITED.....	<i>Croydon, England</i>
INTERNATIONAL MARINE RADIO COMPANY, LIMITED.....	<i>London, England</i>
INTERNATIONAL STANDARD ELECTRIC CORPORATION, <i>Branch Office,</i>	
	<i>Río de Janeiro, Brazil</i>
JUGOSLAVIAN STANDARD ELECTRIC COMPANY, LIMITED.....	<i>Belgrade, Jugoslavia</i>
KOLSTER-BRANDES, LIMITED.....	<i>Sidcup, England</i>
LE MATÉRIEL TÉLÉPHONIQUE.....	<i>Paris, France</i>
<i>Branch: Rabat, Morocco.</i>	
NIPPON DENKI KABUSHIKI KAISHA.....	<i>Tokyo, Japan</i>
<i>Branches: Osaka, Dairen, Taihoku.</i>	
SOCIÉTÉ ANONYME LES TÉLÉIMPRIMEURS.....	<i>Paris, France</i>
STANDARD ELECTRIC AKTIESELSKAB.....	<i>Copenhagen, Denmark</i>
STANDARD ELECTRIC COMPANY W POLSCE SKA Z O. O.....	<i>Warsaw, Poland</i>
STANDARD ELECTRIC DOMS A SPOL.....	<i>Prague, Czechoslovakia</i>
<i>Branch: Bratislava.</i>	
STANDARD ELECTRICA.....	<i>Lisbon, Portugal</i>
STANDARD ELECTRICA ROMÁNÁ, S.A.....	<i>Bucharest, Rumania</i>
STANDARD ELÉCTRICA, S.A.....	<i>Madrid, Spain</i>
<i>Branches: Barcelona, Santander.</i>	
STANDARD ELEKTRIZITÄTS-GESELLSCHAFT A.G.....	<i>Berlin, Germany</i>
STANDARD ELETRICA ITALIANA.....	<i>Milan, Italy</i>
<i>Branch: Rome.</i>	
STANDARD TELEFON-OG KABELFABRIK A/S.....	<i>Oslo, Norway</i>
STANDARD TÉLÉPHONE ET RADIO, S. A. Zürich.....	<i>Zürich, Switzerland</i>
STANDARD TELEPHONES AND CABLES, LIMITED.....	<i>London, England</i>
<i>Branches: Glasgow, Leeds, Dublin, Cairo, Johannesburg, Calcutta.</i>	
STANDARD TELEPHONES AND CABLES (AUSTRALASIA), LIMITED.....	<i>Sydney, Australia</i>
<i>Branches: Melbourne; Wellington, New Zealand.</i>	
STANDARD VILAMOSÁGI RÉSZVÉNY TÁRSASÁG.....	<i>Budapest, Hungary</i>
SUMITOMO ELECTRIC WIRE & CABLE WORKS, LIMITED.....	<i>Osaka, Japan</i>
VEREINIGTE TELEPHON-UND TELEGRAPHENFABRIKS AKTIEN-GESELLSCHAFT, CZEIJA, NISSEL & CO.....	<i>Vienna, Austria</i>

Sales Offices and Agencies Throughout the World
